

## Specifications

### Conditions of Sale

**STANDARD:** The seller's standard conditions of sale set forth in Price Sheets 150 and 153 apply, except as modified under "SPECIAL WARRANTY PROVISIONS" and "WARRANTY QUALIFICATIONS" on page 3.

### SPECIAL TO THIS PRODUCT:

**INCLUSIONS:** Vista SD Underground Distribution Switchgear features load-interrupter switches for switching 600-ampere main feeders and microprocessor-controlled fault interrupters for the switching and protection of 600-ampere main feeders and 200- or 600-ampere taps, laterals, and sub-loops. These elbow-connected components are encapsulated in an environmentally friendly solid-dielectric insulating material. Vista SD switchgear is available with up to six ways (switches and/or fault interrupters) in two ratings: 17.5 kV, 16 kA symmetrical interrupting, and 29 kV, 12.5 kA symmetrical interrupting.

### Load-Interrupter Switches

Visi-Gap Load-Interrupter Switches use a vacuum interrupter in series with a manually operated two-position isolating disconnect for three-pole live switching of 600-ampere three-phase circuits. The switches comply with IEEE 1247, "IEEE Standard for Interrupter Switches for Alternating Current Rated Above 1000 Volts," and IEC Standard 62271-103, "High-Voltage Switches—Part 1—Switches for Rated Voltages Above 1 kV and Less Than 52 kV." They feature an easy-to-operate manual operating mechanism. Factory-installed motor operators to facilitate remote power operation of switches are optionally available (specify catalog number suffix "-B1" through "-B6").

Complete ratings for Visi-Gap Load-Interrupter Switches are shown in Table 1 on page 5. In addition to the load-dropping ratings shown, the switches are capable of interrupting transformer-magnetizing currents associated with the applicable loads as well as line-charging and cable-charging currents typical for distribution systems of these voltage ratings. For applications involving load currents with high harmonic content (such as rectifier load currents), refer to the nearest S&C Sales Office. The duty-cycle fault-closing rating shown for the switch defines the ability to operate the switch into the **Closed** position the designated number of times against a three-phase fault equal to the rated value, with the switch remaining operable and able to carry and interrupt rated current.

### Fault Interrupters

Visi-Gap Fault Interrupters use a vacuum interrupter in series with a manually operated two-position isolating disconnect for three-pole load switching of 200- or 600-ampere circuits and fault interrupting through 16 kA symmetrical at 17.5 kV and through 12.5 kA symmetrical at 29 kV. The fault interrupters comply with IEEE C37.60-2003, "IEEE Standard Requirements for Overhead, Pad-Mounted, Dry Vault, and Subsurface Automatic Circuit Reclosers and Fault Interrupters for Alternating Current Systems Up to 38 kV," and IEC Standard 62271-111, "High-Voltage Switchgear and Control Gear—Overhead, Pad-Mounted, Dry Vault, and Subsurface Automatic Circuit Reclosers for Alternating Current Systems Up to 38 kV."

The easy-to-use manual operating mechanism for Visi-Gap Fault Interrupters is *trip-free* (the opening spring is charged when the closing spring is charged) and will open the fault interrupter automatically based on the TCC curve in the overcurrent control if the fault interrupter is inadvertently closed into a fault. Fault interruption is initiated by a self-powered programmable overcurrent control. Total clearing time (from initiation of the fault to total clearing) can be as fast as 40 milliseconds. Factory-installed motor operators to facilitate remote power operation of the fault interrupters are optionally available (specify catalog number suffix "-B1" through "-B6").

Complete ratings for Visi-Gap Fault Interrupters are shown in Table 1 on page 5. In addition to the load-dropping ratings shown, the fault interrupters are capable of interrupting transformer-magnetizing currents associated with the applicable load as well as line-charging and cable-charging currents typical for distribution systems of these voltage ratings.

### Manual Operation

Load-interrupter switches and fault interrupters can be directly opened and closed using the manual handle furnished; they can also be operated at a distance using a piece of rope attached to the manual handle or by a user-furnished universal pole of the appropriate length equipped with a standard fitting. Opening and closing speed is not dependent on the speed with which the manual handle is moved. The operating mechanisms are designed to prevent inadvertent operation. Operating shafts are padlockable in either position.



## Power Operation

Factory-installed and wired motor operators (specify catalog number suffix “-B1” through “-B6”) are optionally available to facilitate remote power operation of load-interrupter switches and fault interrupters. The motor operators can be decoupled from the operating mechanisms to permit testing without changing the positions of the switches or fault interrupters. The motor operators require a user-furnished 100–240-Vac 50/60-Hz control power source.

The motor operators are controlled by an accessory cable-connected portable remote control pendant featuring OPEN/RESET and CLOSE pushbuttons, operator and isolating-disconnect position-indicating lamps, and a LAMP TEST button. An ENABLE pushbutton must be simultaneously pressed to prevent inadvertent operation of the load-interrupter switch or fault interrupter. When the remote control pendant is plugged into the receptacle of a factory-installed motor operator, the appropriate position-indicating lamp will light to indicate the position of the load-interrupter switch or fault interrupter. A remote control pendant is available with either a 25-foot (762-cm) or a 50-foot (1524-cm) control cable.

## Position Indication

Easy-to-follow mimic bus and indicators on the front of the switchgear assembly convey the positions of load-interrupter switches and fault interrupters (and their isolating disconnects), and whether a fault interrupter has tripped on a fault. The default color scheme is green for **Open/Reset** mode and red for **Closed** mode. To reverse these colors (i.e., green for **Closed** mode and red for **Open/Reset** mode), specify catalog number suffix “-J1.”

Auxiliary contacts furnished on ways on which motor operators have been specified track the positions of both the vacuum interrupter and isolating disconnect associated with each load-interrupter switch or fault-interrupter way. Auxiliary contacts can be optionally furnished on ways *without* motor operators to prepare the switchgear for future automation (specify catalog number suffix “-S1” through “-S6”).

## Viewing Windows

Large viewing windows provide a clear view of the isolating disconnects, allowing operating personnel to easily confirm the positions of load-interrupter switches and fault interrupters.

## Terminals

All terminals are equipped with 600-ampere rated bushing adapters including threaded studs; bushing adapters without the studs are optionally available (specify catalog number suffix “-M1”). Fault interrupters may be optionally equipped with 200-ampere bushing-well adapters instead of 600-ampere bushing adapters (specify catalog number suffix “-M4”). Bushing and bushing-well adapter interfaces

conform to IEEE 386, “IEEE Standard for Separable Insulated Connector Systems for Power Distribution Systems Above 600 V” and accept all standard insulated connectors and inserts.

Bushing and bushing-well adapters can be replaced *in the field* if the stud is cross-threaded during cable installation or if a subsequent termination fault damages the bushing or bushing-well adapter.

Parking stands for load-interrupter switches and fault interrupters are optionally available (specify catalog number suffix “-G1” and/or “-G2,” as required).

Cable-support brackets are provided with each switchgear assembly; these are to prevent damage to the switchgear bushings from mechanical loads developed by unsupported cables. Cable-support brackets are shipped disassembled and must be installed after the switchgear assembly has been moved into its final position.

Cable-support brackets extend below the base of optional pad-mounted style enclosures, if specified. Mount the switchgear assembly on a box pad, provide a cable pit, or specify a base spacer that provides a 12-inch (305 mm) or greater increase in cable-termination height to accommodate the cable-support brackets. Cable-support brackets are not required if the switchgear assembly is supplied with a pad-mounted style enclosure to be installed on a concrete pad.

## Potential Indication with Test Feature

When the optional **Potential Indication** feature is specified (catalog number suffix “-L2”), routine switching can be accomplished by a single person without cable handling or exposure to medium voltage. The **Potential Indication** feature includes provisions for low-voltage phasing. Cable testing can be performed through the back of a user-furnished 600-ampere dead-break connector or 200-ampere feed-thru device, eliminating the need for difficult cable handling.

## Vista Overcurrent Control 2.0

Fault interruption is initiated by a programmable overcurrent control housed in a watertight enclosure. The control is programmed using a personal computer connected to the control via a USB cable (Type A to Type A). The control receives both sensing and control power inputs from current transformers. No batteries are needed for the Vista overcurrent control 2.0.

Current transformers provide power and input signals. The control features a variety of time-current characteristic (TCC) curves—standard “E,” “K,” and “T” speed curves, Vista coordinating-speed tap and main curves, and relay curves per IEEE C37.112-1996.

Coordinating-speed tap curves are used for fault interrupters feeding subloop taps and are specifically designed to optimize coordination with load-side weak-link/backup

current-limiting fuse combinations and source-side relays with low time-dial settings. The coordinating-speed main curves are used for fault interrupters on main feeders and have a longer minimum response time and a different shape to coordinate with tap-interrupter curves. Coordinating-speed curves have **Phase-Overcurrent**, **Ground-Protection**, **Negative-Sequence Fault**, and **Sensitive-Earth Fault** settings.

The coordinating-speed tap and main curves, as well as IEEE and IEC relay TCC curves, can be customized using a variety of **Definite-Time Delay** settings. **Ground Protection**, **Negative-Sequence Fault**, and **Sensitive-Earth Fault** settings are also available.

### Submersible Installations

Vista SD Underground Distribution Switchgear is considerably smaller than traditional air-insulated gear; it can be installed exactly where it's needed. It is completely submersible and thus suitable for installation in subsurface vaults subject to flooding. Both painted mild-steel and unpainted stainless steel stands for mounting the switchgear assembly to the floor are optionally available. Two cable orientations can be accommodated. For switchgear assemblies where the cables enter and exit from the top (operating mechanism at bottom), specify catalog number suffix "-V1." This is the more common cable orientation. For switchgear assemblies where the cables enter and exit from the bottom (operating mechanism at top), specify catalog number suffix "-V2." Single-way switchgear assemblies can also be installed horizontally where the cables enter and exit from the sides; specify catalog number suffix "-V3." See Table 3 on page 12.

Vista SD Underground Distribution Switchgear can be furnished with an optionally available mild-steel or stainless steel pad-mounted-style enclosure for above-grade installations (specify catalog number suffix "-P1" or "-P11"). These enclosures meet the requirements of IEEE C57.12.28, "IEEE Standard for Pad-Mounted Equipment Enclosure Integrity," and C57.12.29, "IEEE Standard for Pad-Mounted Equipment Enclosure Integrity for Coastal Environments." One or more doors provide access to a common cable compartment and are secured by a padlockable top.

A resilient closed-cell gasket on the enclosure bottom flange protects the finish from being scratched during installation and isolates it from the alkalinity of a concrete foundation. All enclosures are protected from corrosion by the Ultradur® II Outdoor Finish; the standard color is olive green, but other colors are optionally available.

**EXCLUSIONS:** The units listed in Table 2 on pages 6 through 11 do not include optional features or accessories listed in Tables 4 and 5 on pages 13 through 17.

### Special Warranty Provisions

The standard warranty contained in the seller's standard conditions of sale, as set forth in Price Sheets 150 and 181, applies only to manual Vista Underground Distribution Switchgear and its associated options. The Vista over-current control 2.0 shall have the following warranty provisions: the first and second paragraphs of Price Sheet 150 warranty are replaced with the following:

**(1) General:** The seller warrants to the immediate purchaser or end user for a period of 10 years from the date of shipment that the equipment delivered will be of the kind and quality specified in the contract description and will be free of defects of workmanship and material. Should any failure to conform to this warranty appear under proper and normal use within 10 years after the date of shipment, the seller agrees, upon prompt notification thereof and confirmation that the equipment has been stored, installed, operated, and maintained in accordance with recommendations of the seller and standard industry practice, to correct the nonconformity either by repairing any damaged or defective parts of the equipment or (at the seller's option) by shipment of necessary replacement parts. The seller's warranty does not apply to any equipment that has been disassembled, repaired, or altered by anyone other than the seller. This limited warranty is granted only to the immediate purchaser or, if the equipment is purchased by a third party for installation in third-party equipment, the end user of the equipment. The seller's duty to perform under any warranty may be delayed, at the seller's sole option, until the seller has been paid in full for all goods purchased by the immediate purchaser. No such delay shall extend the warranty period.

The seller further warrants to the immediate purchaser or end user that for a period of two years from the date of shipment the software will perform substantially in accordance with the then-current release of specifications if properly used in accordance with the procedures described in the seller's instructions. The seller's liability regarding any of the software is expressly limited to exercising its reasonable efforts in supplying or replacing any media found to be physically defective or in correcting defects in the software during the warranty period. The seller does not warrant the use of the software will be uninterrupted or error-free.

**WARRANTY QUALIFICATIONS:** The seller's standard warranty does not apply to components not of S&C manufacture that are supplied and installed by the purchaser or to the ability of seller's equipment to work with such components.

## Anatomy of a Vista SD Switchgear Catalog Number

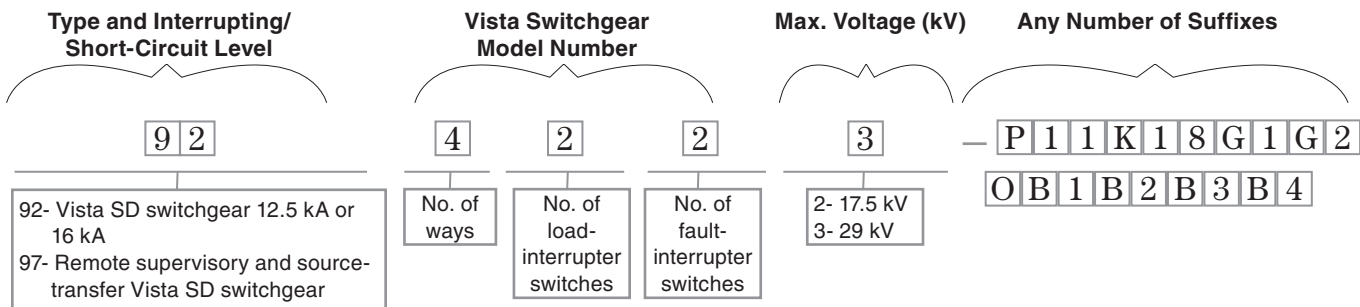

The catalog number created above represents a pad-mounted style Vista SD switchgear unit, 12.5 kA, with a total of four ways that includes two load-interrupter switches and two fault-interrupter switches for a 29-kV application. The unit will have a stainless steel enclosure with an olive green outdoor finish, 12-inch stainless steel base spacers, parking stands for all ways, continuous ground bus, and motor operators on each way.

### How to Order

Complete these steps to identify the base catalog number, the appropriate options, and the product accessories needed for a complete order:

**STEP 1.** Obtain the catalog number of the desired switchgear unit from Table 2 on pages 6 through 11.

**Note:** If the unit will include a low-voltage enclosure for a remote supervisory or source-transfer application, use “97” for the first two digits of this portion of the catalog number.

Catalog Number:

**STEP 2.** Specify the desired switchgear style from Table 3 on page 12 and add the appropriate suffix to the catalog number.

Suffix:

**STEP 3.** Add suffix designations to the catalog number indicating the optional features desired, selected from Table 4 on pages 13 through 16. (Add as many suffixes as required.)

Suffixes:

**Note:** At this point, the catalog number for the Vista SD switchgear unit is complete. The next steps using Table 5 on page 17 and Table 8 on page 17 are for product accessories and touch-up kit components that would be separate line items on the order. Contact S&C for additional available options.

**STEP 4.** Obtain catalog numbers for any accessories from Table 5 on page 17 and apply as a separate line item on the order.

Catalog Number:

**STEP 5.** Include touch-up kit components from Table 8 on page 17.

Catalog Number:

**Example:** The catalog number below is for a remote supervisory pad-mounted style Vista SD switchgear unit, 16 kA, with a total of four ways that are all fault-interrupter switches for a 17.5-kV application. The unit will have a mild steel enclosure with an olive green finish. The unit will also include potential indication, continuous ground bus, motor operators on each way, and an external trip provision (in addition to the Vista overcurrent control 2.0) that requires a 110-120 Vac power source.

9 7 4 0 4 2 — P 1 L 2 O B 1 B 2  
B 3 B 4 R 3 1

**Table 1. 50/60-Hz IEEE Ratings. (IEC Ratings in Parentheses)**

| Voltage, kV  |              |              | Amperes, RMS                |                          |   |                             |   |  |                            |
|--------------|--------------|--------------|-----------------------------|--------------------------|---|-----------------------------|---|--|----------------------------|
| System Class | Max          | BIL          | Main Bus Continuous Current | Short-Circuit, RMS, Sym. | Visi-Gap Load-Interrupter Switch                      |                             |   | Visi-Gap Fault Interrupter                             |                            |
|              |              |              |                             |                          | Cont., Load Dropping, and Load Splitting <sup>①</sup> | Mom. and Three-Second, Sym. | Three-Time, Duty-Cycle Fault Closing, Sym. <sup>②</sup> | Cont., Load Dropping, and Load Splitting <sup>①③</sup> | Short Circuit Interrupting |
| 15<br>(12)   | 17.5<br>(12) | 95<br>(75)   | 600<br>(630)                | 16 000●                  | 600<br>(630)  | 16 000                      | 16 000  | 600<br>(630)   | 16 000●                    |
| 27<br>(24)   | 29<br>(24)   | 125<br>(125) | 600<br>(630)                | 12 500                   | 600<br>(630)  | 12 500                      | 12 500  | 600<br>(630)   | 12 500                     |

① Parallel or loop switching. Load-interrupter switches and fault interrupters can switch the magnetizing current of transformers associated with this rating. Unloaded cable switching capability: 10 amperes at 17.5 kV, 20 amperes at 29 kV. Load-interrupter switches and fault interrupters can also switch single capacitor banks through 1800 kvar.





② Applicable to fault closing into **Closed** position.

③ 200 amperes if fault interrupters are furnished with optional 200-ampere bushing wells.

● 12 500 amperes if fault interrupters are furnished with optional 200-ampere bushing wells.

# Vista® SD Underground Distribution Switchgear

**Table 2. Vista SD Switchgear. IEEE Ratings Shown (IEC Ratings in Parentheses)**

| Model <sup>①②</sup> | Single-Line Diagram   | Ratings      |              |                    |                            | Catalog Number |
|---------------------|---|--------------|--------------|--------------------|----------------------------|----------------|
|                     |   | Voltage, kV  |              | Amperes, RMS, Sym. |                            |                |
|                     |   | Max          | BIL          | Cont. <sup>③</sup> | Short-Circuit <sup>④</sup> |                |
| 110                 |    | 17.5<br>(12) | 95<br>(75)   | 600<br>(630)       | 16 000<br>(16 000)         | 921102         |
|                     |   | 29<br>(24)   | 125<br>(125) | 600<br>(630)       | 12 500<br>(12 500)         | 921103         |
| 101                 |    | 17.5<br>(12) | 95<br>(75)   | 600<br>(630)       | 16 000<br>(16 000)         | 921012         |
|                     |   | 29<br>(24)   | 125<br>(125) | 600<br>(630)       | 12 500<br>(12 500)         | 921013         |
| 210●■               |   | 17.5<br>(12) | 95<br>(75)   | 600<br>(630)       | 16 000<br>(16 000)         | 922102         |
|                     |   | 29<br>(24)   | 125<br>(125) | 600<br>(630)       | 12 500<br>(12 500)         | 922103         |
| 201●▲               |  | 17.5<br>(12) | 95<br>(75)   | 600<br>(630)       | 16 000<br>(16 000)         | 922012         |
|                     |   | 29<br>(24)   | 125<br>(125) | 600<br>(630)       | 12 500<br>(12 500)         | 922013         |

① The model number defines the total number of ways, the number of load-interrupter switch ways, and the number of fault-interrupter ways. For example, Model 101 is a single-way assembly with “1” fault-interrupter way.

② For standard models, components are in the following order (from left to right) when facing the gear: load-interrupter switches, fault interrupters.

③ 200 amperes if fault interrupters are furnished with optional 200-ampere bushing wells.

④ 12 500 amperes if fault interrupters are furnished with optional 200-ampere bushing wells.

● Only available with pad-mounted style enclosure (catalog number suffix “-P1” or “-P11”).

■ Components are in the following order (left to right) when facing the switchgear: load-interrupter switch, bus tap.

▲ Components are in the following order (left to right) when facing the switchgear: fault interrupter, bus tap.

TABLE CONTINUED ►

Table 2. Vista SD Switchgear. IEEE Ratings Shown (IEC Ratings in Parentheses)—Continued

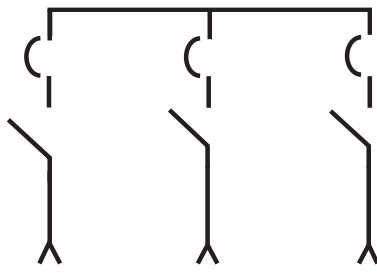
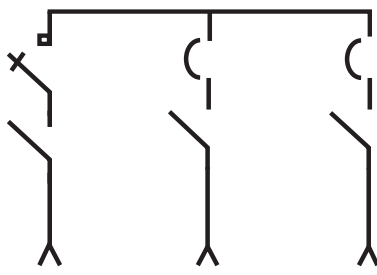
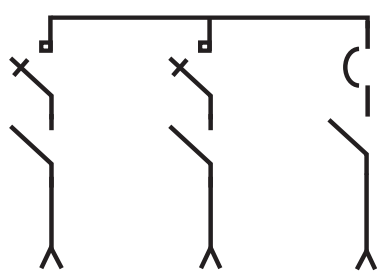
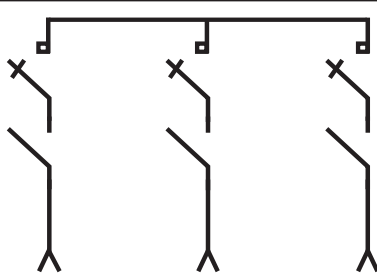
| Model <sup>①②</sup> | Single-Line Diagram   | Ratings      |              |                    |                            | Catalog Number |
|---------------------|---|--------------|--------------|--------------------|----------------------------|----------------|
|                     |   | Voltage, kV  |              | Amperes, RMS, Sym. |                            |                |
|                     |   | Max          | BIL          | Cont. <sup>③</sup> | Short-Circuit <sup>④</sup> |                |
| 303                 |    | 17.5<br>(12) | 95<br>(75)   | 600<br>(630)       | 16 000<br>(16 000)         | 923032         |
|                     |   | 29<br>(24)   | 125<br>(125) | 600<br>(630)       | 12 500<br>(12 500)         | 923033         |
| 312                 |    | 17.5<br>(12) | 95<br>(75)   | 600<br>(630)       | 16 000<br>(16 000)         | 923122         |
|                     |   | 29<br>(24)   | 125<br>(125) | 600<br>(630)       | 12 500<br>(12 500)         | 923123         |
| 321                 |   | 17.5<br>(12) | 95<br>(75)   | 600<br>(630)       | 16 000<br>(16 000)         | 923212         |
|                     |   | 29<br>(24)   | 125<br>(125) | 600<br>(630)       | 12 500<br>(12 500)         | 923213         |
| 330                 |  | 17.5<br>(12) | 95<br>(75)   | 600<br>(630)       | 16 000<br>(16 000)         | 923302         |
|                     |   | 29<br>(24)   | 125<br>(125) | 600<br>(630)       | 12 500<br>(12 500)         | 923303         |

① The model number defines the total number of ways, the number of load-interrupter switch ways, and the number of fault-interrupter ways. For example, Model 312 has “3” ways in total, “1” load-interrupter switch way and “2” fault-interrupter ways.

② For standard models, components are in the following order (from left to right) when facing the gear: load-interrupter switches, fault interrupters.

③ 200 amperes if fault interrupters are furnished with optional 200-ampere bushing wells.

④ 12 500 amperes if fault interrupters are furnished with optional 200-ampere bushing wells.

TABLE CONTINUED ►

# Vista® SD Underground Distribution Switchgear

**Table 2. Vista SD Switchgear. IEEE Ratings Shown (IEC Ratings in Parentheses)—Continued**

| Model <sup>①②</sup> | Single-Line Diagram | Ratings      |              |                    |                            | Catalog Number |
|---------------------|---------------------|--------------|--------------|--------------------|----------------------------|----------------|
|                     |                     | Voltage, kV  |              | Amperes, RMS, Sym. |                            |                |
|                     |                     | Max          | BIL          | Cont. <sup>③</sup> | Short-Circuit <sup>④</sup> |                |
| 404                 |                     | 17.5<br>(12) | 95<br>(75)   | 600<br>(630)       | 16 000<br>(16 000)         | 924042         |
|                     |                     | 29<br>(24)   | 125<br>(125) | 600<br>(630)       | 12 500<br>(12 500)         | 924043         |
| 413                 |                     | 17.5<br>(12) | 95<br>(75)   | 600<br>(630)       | 16 000<br>(16 000)         | 924132         |
|                     |                     | 29<br>(24)   | 125<br>(125) | 600<br>(630)       | 12 500<br>(12 500)         | 924133         |
| 422                 |                     | 17.5<br>(12) | 95<br>(75)   | 600<br>(630)       | 16 000<br>(16 000)         | 924222         |
|                     |                     | 29<br>(24)   | 125<br>(125) | 600<br>(630)       | 12 500<br>(12 500)         | 924223         |
| 431                 |                     | 17.5<br>(12) | 95<br>(75)   | 600<br>(630)       | 16 000<br>(16 000)         | 924312         |
|                     |                     | 29<br>(24)   | 125<br>(125) | 600<br>(630)       | 12 500<br>(12 500)         | 924313         |
| 440                 |                     | 17.5<br>(12) | 95<br>(75)   | 600<br>(630)       | 16 000<br>(16 000)         | 924402         |
|                     |                     | 29<br>(24)   | 125<br>(125) | 600<br>(630)       | 12 500<br>(12 500)         | 924403         |

① Model number defines the total number of ways, the number of load-interrupter switch ways, and the number of fault-interrupter ways. For example, Model 413 has “4” ways in total, “1” load-interrupter switch way and “3” fault-interrupter ways.

② For standard models, components are in the following order (from left to right) when facing the gear: load-interrupter switches, fault interrupters.

③ 200 amperes if fault interrupters are furnished with optional 200-ampere bushing wells.

④ 12 500 amperes if fault interrupters are furnished with optional 200-ampere bushing wells.

TABLE CONTINUED ►



Table 2. Vista SD Switchgear. IEEE Ratings Shown (IEC Ratings in Parentheses)—Continued

| Model <sup>①②</sup> | Single-Line Diagram | Ratings      |              |                    |                            | Catalog Number |
|---------------------|---------------------|--------------|--------------|--------------------|----------------------------|----------------|
|                     |                     | Voltage, kV  |              | Amperes, RMS, Sym. |                            |                |
|                     |                     | Max          | BIL          | Cont. <sup>③</sup> | Short-Circuit <sup>④</sup> |                |
| 505                 |                     | 17.5<br>(12) | 95<br>(75)   | 600<br>(630)       | 16 000<br>(16 000)         | 925052         |
|                     |                     | 29<br>(24)   | 125<br>(125) | 600<br>(630)       | 12 500<br>(12 500)         | 925053         |
| 514                 |                     | 17.5<br>(12) | 95<br>(75)   | 600<br>(630)       | 16 000<br>(16 000)         | 925142         |
|                     |                     | 29<br>(24)   | 125<br>(125) | 600<br>(630)       | 12 500<br>(12 500)         | 925143         |
| 523                 |                     | 17.5<br>(12) | 95<br>(75)   | 600<br>(630)       | 16 000<br>(16 000)         | 925232         |
|                     |                     | 29<br>(24)   | 125<br>(125) | 600<br>(630)       | 12 500<br>(12 500)         | 925233         |
| 532                 |                     | 17.5<br>(12) | 95<br>(75)   | 600<br>(630)       | 16 000<br>(16 000)         | 925322         |
|                     |                     | 29<br>(24)   | 125<br>(125) | 600<br>(630)       | 12 500<br>(12 500)         | 925323         |

① Model number defines the total number of ways, the number of load-interrupter switch ways, and the number of fault-interrupter ways. For example, Model 514 has “5” ways in total, “1” load-interrupter switch way and “4” fault-interrupter ways.

② For standard models, components are in the following order (from left to right) when facing the gear: load-interrupter switches, fault interrupters.

③ 200 amperes if fault interrupters are furnished with optional 200-ampere bushing wells.

④ 12 500 amperes if fault interrupters are furnished with optional 200-ampere bushing wells.

TABLE CONTINUED ►

# Vista® SD Underground Distribution Switchgear

**Table 2. Vista SD Switchgear. IEEE Ratings Shown (IEC Ratings in Parentheses)—Continued**

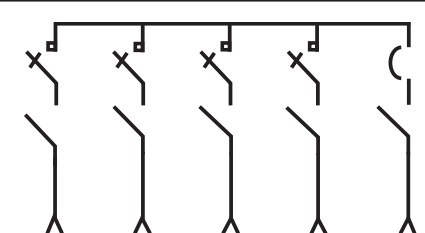
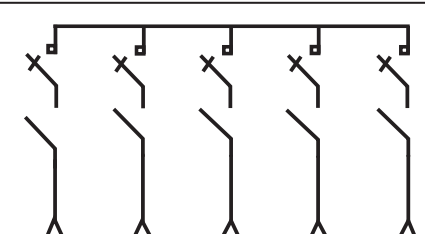
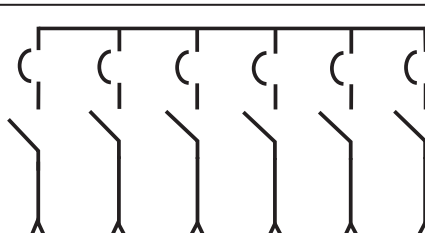
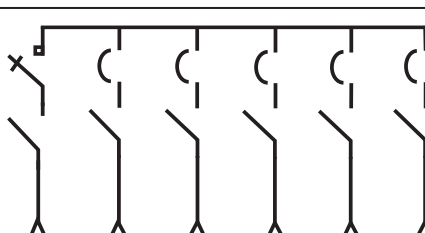
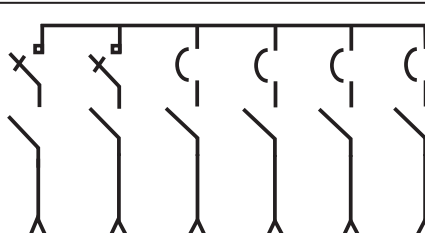
| Model <sup>①②</sup> | Single-Line Diagram   | Ratings      |              |                    |                            | Catalog Number |
|---------------------|---|--------------|--------------|--------------------|----------------------------|----------------|
|                     |   | Voltage, kV  |              | Amperes, RMS, Sym. |                            |                |
|                     |   | Max          | BIL          | Cont. <sup>③</sup> | Short-Circuit <sup>④</sup> |                |
| 541                 |    | 17.5<br>(12) | 95<br>(75)   | 600<br>(630)       | 16 000<br>(16 000)         | 925412         |
|                     |   | 29<br>(24)   | 125<br>(125) | 600<br>(630)       | 12 500<br>(12 500)         | 925413         |
| 550                 |    | 17.5<br>(12) | 95<br>(75)   | 600<br>(630)       | 16 000<br>(16 000)         | 925502         |
|                     |   | 29<br>(24)   | 125<br>(125) | 600<br>(630)       | 12 500<br>(12 500)         | 925503         |
| 606                 |   | 17.5<br>(12) | 95<br>(75)   | 600<br>(630)       | 16 000<br>(16 000)         | 926062         |
|                     |   | 29<br>(24)   | 125<br>(125) | 600<br>(630)       | 12 500<br>(12 500)         | 926063         |
| 615                 |  | 17.5<br>(12) | 95<br>(75)   | 600<br>(630)       | 16 000<br>(16 000)         | 926152         |
|                     |   | 29<br>(24)   | 125<br>(125) | 600<br>(630)       | 12 500<br>(12 500)         | 926153         |
| 624                 |  | 17.5<br>(12) | 95<br>(75)   | 600<br>(630)       | 16 000<br>(16 000)         | 926242         |
|                     |   | 29<br>(24)   | 125<br>(125) | 600<br>(630)       | 12 500<br>(12 500)         | 926243         |

① Model number defines the total number of ways, the number of load-interrupter switch ways, and the number of fault-interrupter ways. For example, Model 615 has “6” ways in total, “1” load-interrupter switch way and “5” fault-interrupter ways.

② For standard models, components are in the following order (from left to right) when facing the gear: load-interrupter switches, fault interrupters.

③ 200 amperes if fault interrupters are furnished with optional 200-ampere bushing wells.

④ 12 500 amperes if fault interrupters are furnished with optional 200-ampere bushing wells.

TABLE CONTINUED ►

Table 2. Vista SD Switchgear. IEEE Ratings Shown (IEC Ratings in Parentheses)—Continued

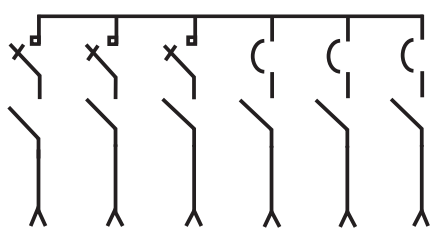
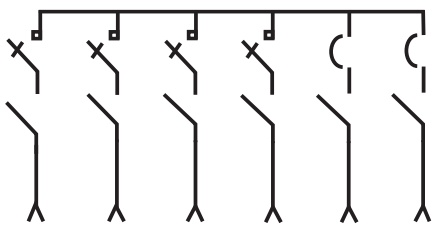
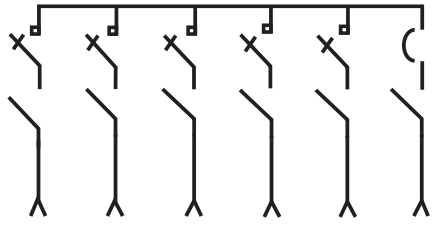
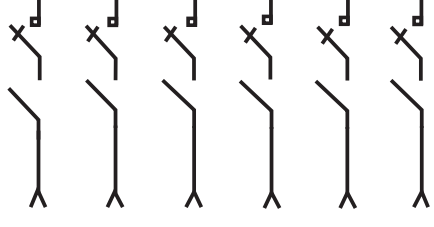
| Model <sup>①②</sup> | Single-Line Diagram   | Ratings      |              |                    |                            | Catalog Number |
|---------------------|---|--------------|--------------|--------------------|----------------------------|----------------|
|                     |   | Voltage, kV  |              | Amperes, RMS, Sym. |                            |                |
|                     |   | Max          | BIL          | Cont. <sup>③</sup> | Short-Circuit <sup>④</sup> |                |
| 633                 |    | 17.5<br>(12) | 95<br>(75)   | 600<br>(630)       | 16 000<br>(16 000)         | 926332         |
|                     |   | 29<br>(24)   | 125<br>(125) | 600<br>(630)       | 12 500<br>(12 500)         | 926333         |
| 642                 |    | 17.5<br>(12) | 95<br>(75)   | 600<br>(630)       | 16 000<br>(16 000)         | 926422         |
|                     |   | 29<br>(24)   | 125<br>(125) | 600<br>(630)       | 12 500<br>(12 500)         | 926423         |
| 651                 |   | 17.5<br>(12) | 95<br>(75)   | 600<br>(630)       | 16 000<br>(16 000)         | 926512         |
|                     |   | 29<br>(24)   | 125<br>(125) | 600<br>(630)       | 12 500<br>(12 500)         | 926513         |
| 660                 |  | 17.5<br>(12) | 95<br>(75)   | 600<br>(630)       | 16 000<br>(16 000)         | 926602         |
|                     |   | 29<br>(24)   | 125<br>(125) | 600<br>(630)       | 12 500<br>(12 500)         | 926603         |

① Model number defines the total number of ways, the number of load-interrupter switch ways, and the number of fault-interrupter ways. For example, Model 633 has “6” ways in total, “3” load-interrupter switch ways and “3” fault-interrupter ways.

② For standard models, components are in the following order (from left to right) when facing the gear: load-interrupter switches, fault interrupters.

③ 200 amperes if fault interrupters are furnished with optional 200-ampere bushing wells.

④ 12 500 amperes if fault interrupters are furnished with optional 200-ampere bushing wells.

# Vista® SD Underground Distribution Switchgear

**Table 3. Switchgear Style—Must be Specified**

| Item  |   | Suffix to be Added to Switchgear Catalog Number | Applicable to Models              |                                   |
|---|---|---|-----------------------------------|-----------------------------------|
| Vault-mounted style. Where switchgear assembly is floor-mounted. Includes submersible wiring and control housing <sup>①</sup>   | Vertical orientation, cables enter/exit from top, operating mechanism on bottom | Mild steel mounting stand                       | -V1                               | 110, 101                          |
|   |   |   |                                   | 303, 312, 321, 330                |
|   |   |   |                                   | 404, 413, 422, 431, 440           |
|   |   |   |                                   | 505, 514, 523, 532, 541, 550      |
|   |   |   |                                   | 606, 615, 624, 633, 642, 651, 660 |
|   | Stainless steel mounting stand  | -V11  | 110, 101                          |                                   |
|   |   |   | 303, 312, 321, 330                |                                   |
|   |   |   | 404, 413, 422, 431, 440           |                                   |
|   |   |   | 505, 514, 523, 532, 541, 550      |                                   |
|   |   |   | 606, 615, 624, 633, 642, 651, 660 |                                   |
|   | Vertical orientation, cables enter/exit from bottom, operating mechanism on top | Mild steel mounting stand                       | -V2                               | 110, 101                          |
|   |   |   |                                   | 303, 312, 321, 330                |
| 404, 413, 422, 431, 440   |   |   |                                   |                                   |
| 505, 514, 523, 532, 541, 550  |   |   |                                   |                                   |
| 606, 615, 624, 633, 642, 651, 660   |   |   |                                   |                                   |
| Stainless steel mounting stand  |   | -V12  | 110, 101                          |                                   |
|   |   |   | 303, 312, 321, 330                |                                   |
|   |   |   | 404, 413, 422, 431, 440           |                                   |
|   |   |   | 505, 514, 523, 532, 541, 550      |                                   |
|   |   |   | 606, 615, 624, 633, 642, 651, 660 |                                   |
| Horizontal orientation, cables enter/exit from sides  | Mild steel mounting stand   | -V3   | 110, 101                          |                                   |
|   | Stainless steel mounting stand  | -V13  | 110, 101                          |                                   |
| Pad-mounted-style. Includes pad-mounted style enclosure with olive green outdoor finish. Single-sided access facilitates installation adjacent to wall or other structure | Mild steel enclosure  | -P1   | 210, 201                          |                                   |
|   |   |   | 303, 312, 321, 330                |                                   |
|   |   |   | 404, 413, 422, 431, 440           |                                   |
|   |   |   | 505, 514, 523, 532, 541, 550      |                                   |
|   |   |   | 606, 615, 624, 633, 642, 651, 660 |                                   |
|   | Stainless steel enclosure   | -P11  | 210, 201                          |                                   |
|   |   |   | 303, 312, 321, 330                |                                   |
|   |   |   | 404, 413, 422, 431, 440           |                                   |
|   |   |   | 505, 514, 523, 532, 541, 550      |                                   |
|   |   |   | 606, 615, 624, 633, 642, 651, 660 |                                   |

<sup>①</sup> For wall-mounted applications, refer to your nearest S&C Sales Office.

Table 4. Optional Features

| Item  |  | Suffix to be Added to Switchgear Catalog Number | Applicable to Models              |          |
|---|--|---|-----------------------------------|----------|
| Alternate-color outdoor finish <sup>①</sup>   | Light gray   | -A  | All                               |          |
|   | Equipment green  | -A3   |                                   |          |
|   | Seafoam green  | -A4   |                                   |          |
|   | Special color  | -A5   |                                   |          |
| Hexhead bolt instead of pentahead bolt <sup>①</sup>   |  | -H1   | All                               |          |
| Base spacer with olive green outdoor finish, increases cable-termination height <sup>①</sup>  | Mild steel   | 6 inches (152 mm)                               | -K7                               | 210, 201 |
|   |  |   | 303, 312, 321, 330                |          |
|   |  |   | 404, 413, 422, 431, 440           |          |
|   |  |   | 505, 514, 523, 532, 541, 550      |          |
|   |  |   | 606, 615, 624, 633, 642, 651, 660 |          |
|   | Mild steel   | 12 inches (305 mm)                              | -K8                               | 210, 201 |
|   |  |   | 303, 312, 321, 330                |          |
|   |  |   | 404, 413, 422, 431, 440           |          |
|   |  |   | 505, 514, 523, 532, 541, 550      |          |
|   |  |   | 606, 615, 624, 633, 642, 651, 660 |          |
|   | Stainless steel  | 6 inches (152 mm)                               | -K17                              | 210, 201 |
|   |  |   | 303, 312, 321, 330                |          |
|   |  |   | 404, 413, 422, 431, 440           |          |
|   |  |   | 505, 514, 523, 532, 541, 550      |          |
|   |  |   | 606, 615, 624, 633, 642, 651, 660 |          |
|   | Stainless steel  | 12 inches (305 mm)                              | -K18                              | 210, 201 |
| 303, 312, 321, 330  |  |   |                                   |          |
| 404, 413, 422, 431, 440   |  |   |                                   |          |
| 505, 514, 523, 532, 541, 550  |  |   |                                   |          |
| 606, 615, 624, 633, 642, 651, 660   |  |   |                                   |          |
| Mounting provisions for fault indicator for each load-interrupter switch. Accommodates three-phase indicator with single-phase sensors <sup>①</sup> | Pad-mounted style enclosure with no viewing window in door | -F1   | 210, 312, 413, 514                |          |
|   |  |   | 321, 422, 523, 624                |          |
|   |  |   | 330, 431, 633                     |          |
|   |  |   | 440                               |          |
|   |  |   | 550                               |          |
|   |  |   | 660                               |          |
|   | Pad-mounted style enclosure with viewing window in door    | -F2   | 210, 312, 413, 514                |          |
|   |  |   | 321, 422, 523, 624                |          |
|   |  |   | 330, 431, 633                     |          |
|   |  |   | 440                               |          |
|   |  |   | 550                               |          |
|   |  |   | 660                               |          |

<sup>①</sup> Applicable to switchgear assemblies with a pad-mounted-style enclosure (catalog number suffix "-P1" or "-P11").

TABLE CONTINUED ►

# Vista® SD Underground Distribution Switchgear

**Table 4. Optional Features—Continued**

| Item   |   | Suffix to be Added to Switchgear Catalog Number | Applicable to Models              |
|--|---|---|-----------------------------------|
| Parking Stands   | At all load-interrupter switches and bus taps | -G1   | 110●, 312, 413, 514               |
|  |   |   | 210, 321, 422, 523, 624           |
|  |   |   | 330, 431, 532, 633                |
|  |   |   | 440                               |
|  |   |   | 550                               |
|  | At all fault interrupters and bus taps        | -G2   | 101●, 321, 431                    |
|  |   |   | 201, 312, 422, 532, 642           |
|  |   |   | 303, 413, 523, 633                |
|  |   |   | 404, 514, 624                     |
|  |   |   | 505, 615                          |
|  |   |   | 606                               |
| Reverse color of the OPEN/RESET and CLOSED indicators (i.e., green for <b>Closed</b> mode and red for <b>Open/Reset</b> mode)  |   | -J1   | All                               |
| Potential indication. Indicates presence of voltage on each phase. One indicator is provided for each load-interrupter switch and fault interrupter way. Includes provisions for low-voltage phasing   |   | -L2   | 110, 101, 210, 201                |
|  |   |   | 303, 312, 321, 330                |
|  |   |   | 404, 413, 422, 431, 440           |
|  |   |   | 505, 514, 523, 532, 541, 550      |
|  |   |   | 606, 615, 624, 633, 642, 651, 660 |
| 600-ampere bushing adapters <i>without</i> studs on all load-interrupter switches, fault interrupters, and bus terminals (instead of 600-ampere bushing adapters <i>with</i> studs)  |   | -M1   | All                               |
| 200-ampere bushing-well adapters on all load interrupters, fault interrupters, and bus taps, instead of 600-ampere bushing adapters. Interrupting rating of fault interrupters is 12,500 amperes when 200-ampere bushing-well adapters are furnished |   | -M4   | 101■, 201▲, 321, 431, 541, 651    |
|  |   |   | 312, 422                          |
|  |   |   | 303, 413, 523, 633                |
|  |   |   | 404, 514, 624                     |
|  |   |   | 505, 615                          |
|  |   |   | 606                               |

- Parking stands will only be supplied on the entrance (center) set of bushings.
- 200-ampere bushing wells will be installed on lower bushings.
- ▲ 200-ampere bushing wells will be installed on bus tap bushings.

TABLE CONTINUED ►

Table 4. Optional Features—Continued

| Item   | Suffix to be Added to Switchgear Catalog Number | Applicable to Models              |     |
|--|---|-----------------------------------|-----|
| Continuous ground bus. Connects to all load-interrupter switches and fault interrupters; provides convenient location to attach cable concentric neutrals, separable connector drain wires, and user-provided grounding cables. Short-circuit rating of ground bus equals that of the switchgear assembly          | -O  | 110, 101, 210, 201                |     |
|  |   | 303, 312, 321, 330                |     |
|  |   | 404, 413, 422, 431, 440           |     |
|  |   | 505, 514, 523, 532, 541, 550      |     |
|  |   | 606, 615, 624, 633, 642, 651, 660 |     |
| Motor operator. <sup>①②</sup> Permits remote operation of load-interrupter switch or fault interrupter. Includes receptacle for wired portable remote control pendant, plus auxiliary contacts to track position of the isolating disconnect. Requires user-furnished 120–240-Vac, 50/60-Hz control power source   | Way 1   | -B1                               | All |
|  | Way 2   | -B2                               |     |
|  | Way 3   | -B3                               |     |
|  | Way 4   | -B4                               |     |
|  | Way 5   | -B5                               |     |
|  | Way 6   | -B6                               |     |
| Auxiliary contacts for way not furnished with motor operator. <sup>③</sup> Includes a cable with connector for attachment to the portable motor operator, enabling position indication of both the vacuum interrupter and isolating disconnect on the remote-control pendant used with the portable motor operator | Way 1   | -S1                               | All |
|  | Way 2   | -S2                               |     |
|  | Way 3   | -S3                               |     |
|  | Way 4   | -S4                               |     |
|  | Way 5   | -S5                               |     |
|  | Way 6   | -S6                               |     |

① Order portable remote control pendant, one per switchgear assembly; see Table 5 on page 17.

② For Models 210 and 201, specify motor operator on Way 1 only (catalog number suffix “-B1”).

③ For Models 210 and 201, specify auxiliary contacts on Way 1 only (catalog number suffix “-S1”).

TABLE CONTINUED ►

# Vista® SD Underground Distribution Switchgear

**Table 4. Optional Features—Continued**

| Item  |   | Suffix to be Added to Switchgear Catalog Number | Applicable to Models              |
|---|---|---|-----------------------------------|
| Key interlock.① Locks load-interrupter switch or fault interrupter in open position. Locks load-interrupter switch or fault interrupter in the <b>Open</b> position. Kirk Key interlocks provided as standard | Way 1   | -X1   | All                               |
|   | Way 2   | -X2   |                                   |
|   | Way 3   | -X3   |                                   |
|   | Way 4   | -X4   |                                   |
|   | Way 5   | -X5   |                                   |
|   | Way 6   | -X6   |                                   |
| External trip provisions.② Allow tripping of fault interrupters using trip signal from remote location or external relay. Requires user-furnished 110–120-Vac, 50/60-Hz control power source                  | In addition to standard overcurrent control for all fault interrupters                      | -R31  | 101, 201, 321, 431, 541, 651      |
|   |   |   | 312, 422, 532, 642                |
|   |   |   | 303, 413, 523, 633                |
|   |   |   | 404, 514, 624                     |
|   |   |   | 505, 615                          |
|   |   |   | 606                               |
|   | Instead of standard overcurrent control and current transformers for all fault interrupters | -R41  | 101, 201, 321, 431, 541, 651      |
|   |   |   | 312, 422, 532, 642                |
|   |   |   | 303, 413, 523, 633                |
|   |   |   | 404, 514, 624                     |
|   |   |   | 505, 615                          |
|   |   |   | 606                               |
| External trip provisions.② Allow tripping of fault interrupters using trip signal from remote location or external relay. Requires user-furnished 220–240-Vac, 50/60-Hz control power source                  | In addition to standard overcurrent control for all fault interrupters                      | -R33  | 101, 201, 321, 431, 541, 651      |
|   |   |   | 312, 422, 532, 642                |
|   |   |   | 303, 413, 523, 633                |
|   |   |   | 404, 514, 624                     |
|   |   |   | 505, 615                          |
|   |   |   | 606                               |
|   | Instead of standard overcurrent control and current transformers for all fault interrupters | -R43  | 101, 201, 321, 431, 541, 651      |
|   |   |   | 312, 422, 532, 642                |
|   |   |   | 303, 413, 523, 633                |
|   |   |   | 404, 514, 624                     |
|   |   |   | 505, 615                          |
|   |   |   | 606                               |
| Alternate-language labels   | Spanish   | -L51  | All                               |
|   | Portuguese  | -L52  |                                   |
|   | French  | -L53  |                                   |
|   | Chinese   | -L54  |                                   |
|   | Arabic  | -L55  |                                   |
| International crating. Wood products used in packaging are hardwood or certified by supplier to be “heat-treated” (kiln-dried) to a core temperature of 133°F (56°C) for a minimum of 30 minutes              |   | -L71  | 110, 101                          |
|   |   |   | 210, 201                          |
|   |   |   | 303, 312, 321, 330                |
|   |   |   | 404, 413, 422, 431, 440           |
|   |   |   | 505, 514, 523, 532, 541, 550      |
|   |   |   | 606, 615, 624, 633, 642, 651, 660 |

① For Models 210 and 201, specify key interlock on Way 1 only (catalog number suffix “-X1”).

② The user-furnished trip-initiating signal must be a momentary contact. For applications requiring the use of a latching contact, refer to the nearest S&C Sales Office for assistance.



**Table 5. Accessories**

| Item   | Catalog Number                 |          |
|--|--------------------------------|----------|
| Shotgun clamp stick—for use with separable connectors  | 6-foot-5½-inch (197-cm) length | 9933-150 |
|  | 8-foot-½-inch (245-cm) length  | 9933-151 |
| Storage bag for shotgun clamp stick. Heavy canvas  | 6-foot-6-inch (198-cm) length  | 9933-152 |
|  | 8-foot-6-inch (259-cm) length  | 9933-153 |
| Pentahead socket for ½-inch drive  | 9931-074                       |          |
| Motor operator.①② Facilitates power operation of load-interrupter switches or fault interrupters. Can be permanently attached to load-interrupter switches or fault interrupters or can be used as a portable motor operator to effect operation of a load-interrupter switch or fault interrupter from a remote location. Requires user-furnished 120–240-Vac, 50/60-Hz control power source. Motor operator is fully submersible | 38415-A                        |          |
| Portable remote control pendant with 25-foot (762-cm) cable.③ Includes OPEN/RESET, CLOSE, and ENABLE push-buttons, operator and isolating-disconnect position-indicating lamps, and LAMP TEST button. Pendant is fully submersible   | TA-3273-25                     |          |
| Portable remote control pendant with 50-foot (1524-cm) cable.③ Includes OPEN/RESET, CLOSE, and ENABLE push-buttons, operator and isolating-disconnect position-indicating lamps, and LAMP TEST button. Pendant is fully submersible  | TA-3273-50                     |          |

① Order portable remote control pendant, one per switchgear assembly or one for each portable motor operator.

② If switchgear is furnished with optional auxiliary contacts (catalog number suffix “-S1” through “-S6”), portable remote control pendant will show position of load-interrupter switch or fault interrupter and position of isolating disconnect.

③ Default color scheme for operator and isolating-disconnect position-indicating lamps is green for “Open/Reset” and red for “Closed.” To reverse these colors, (i.e., green for “Closed” and red for “Open/Reset”), specify catalog number suffix “-J1.”

**Table 6. Replacement Parts**

| Item  | Catalog Number |
|---|----------------|
| 600-ampere bushing adapter kit                                  | CHA-1976●      |
| 200-ampere bushing-well adapter kit                             | CHA-1975●      |
| Tool for removing/installing bushing and bushing-well adapters① | CH-2728        |

① Tool can be used to remove/install 600-ampere bushing adapters; must be used to remove/install 200-ampere bushing-well adapters.

● Adapter kits are for a single phase. Order quantity (3) adapters for each way.

**Table 7. Vista Overcurrent Control 2.0 Replacement Parts**

| Item  | Catalog Number |
|---|----------------|
| Vista overcurrent control 2.0 connection cable (For connecting the control to a user PC for programming and status information. This 2-meter (6.6-foot) long cable includes a USB Type A-to-Type A connection.) | TR-11887       |

**Table 8. Touch-Up Kit Components—Aerosol Coatings in 9-ounce Cans**

| Item                               | Catalog Number |
|------------------------------------|----------------|
| S&C light gray outdoor finish      | 9999-080       |
| S&C olive green outdoor finish     | 9999-058       |
| S&C seafoam green outdoor finish   | 9991363-493    |
| S&C equipment green outdoor finish | 9991363-488    |
| S&C red-oxide primer               | 9999-061       |

# Vista® SD Underground Distribution Switchgear

## Wet-Vault Installation Style—Single-Way Assembly—Vertical Orientation

Catalog number suffix “-V1” or “-V11” (Cables enter/exit from the top, operating mechanism at bottom)  
 Model 110 shown

Dimensions in inches (mm)  
 Net weight: 500 lbs. (227 kg)

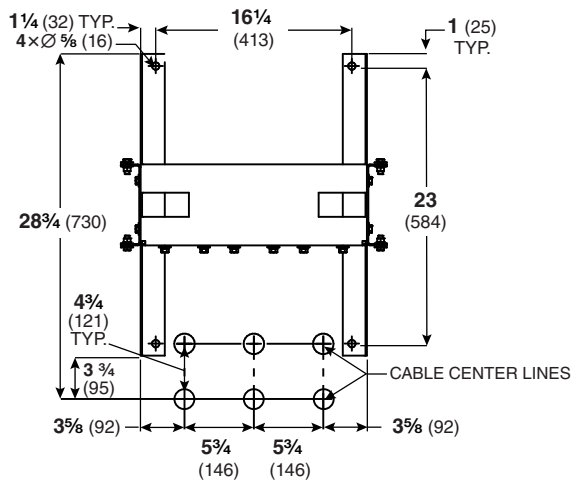
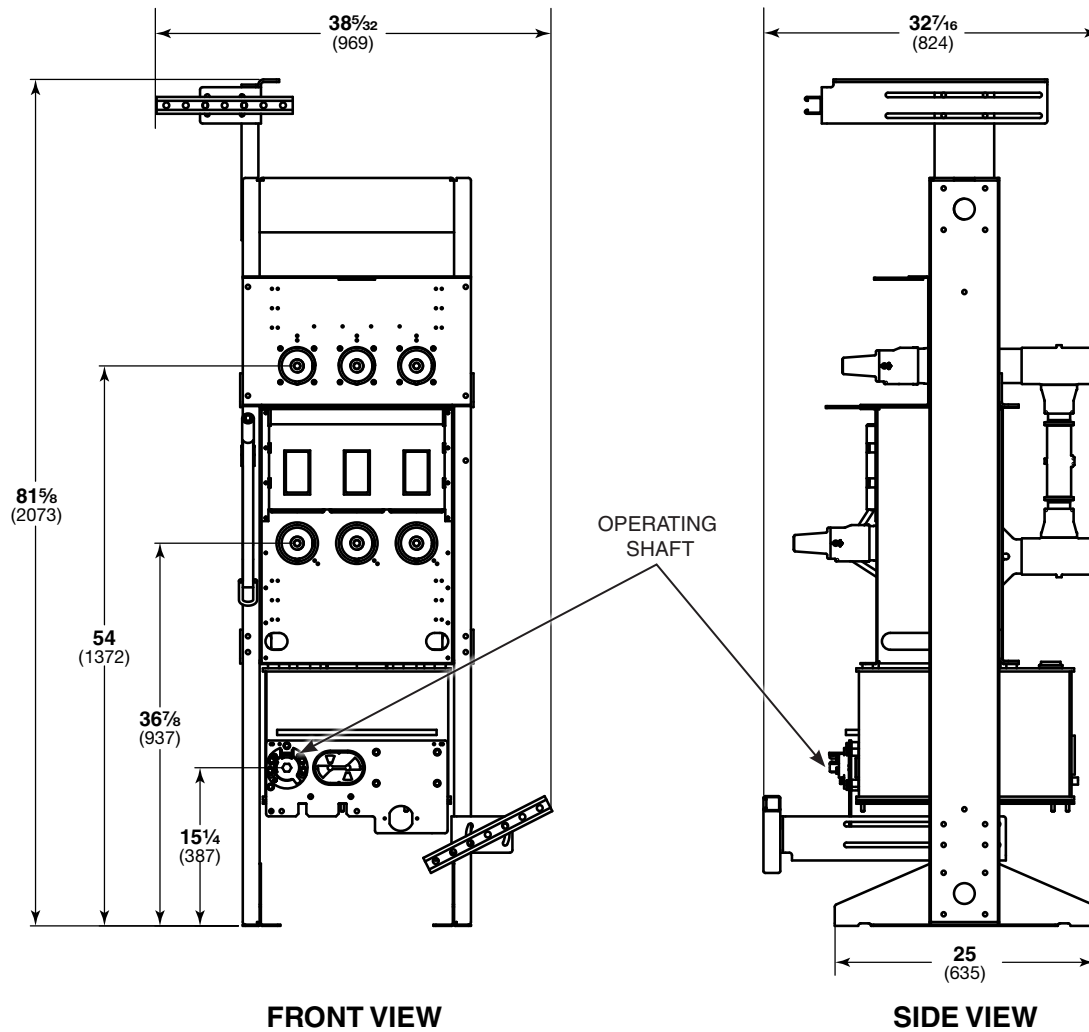

**ANCHOR BOLT PLAN**

**Wet-Vault Installation Style—Single-Way Assembly—Vertical Orientation**

Catalog number suffix “-V2” or “V12” (Cables enter/exit from the bottom, operating mechanism at top)  
 Model 110 shown

Dimensions in inches (mm)  
 Net weight: 500 lbs. (227 kg)

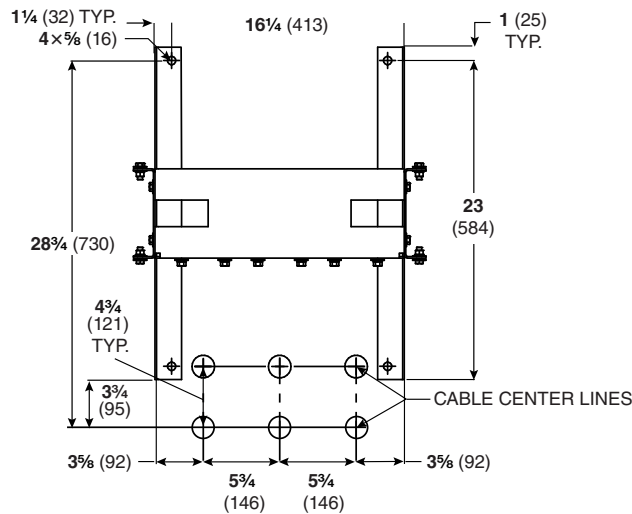
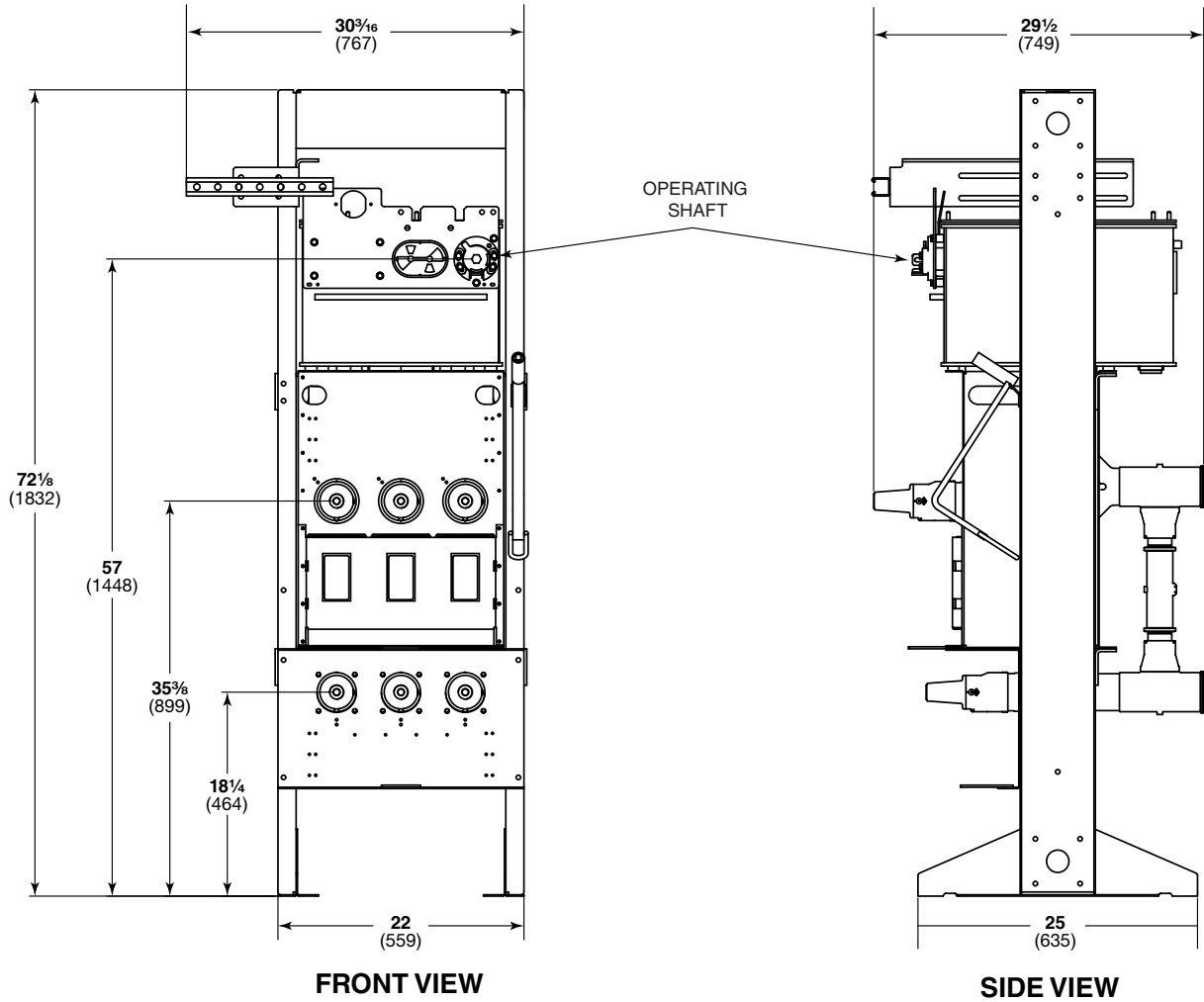

**ANCHOR BOLT PLAN**

# Vista® SD Underground Distribution Switchgear

## Wet-Vault Installation Style—Single-Way Assembly—Horizontal Orientation

Catalog number suffix “-V3” or “-V13” (Cables enter/exit from the sides, operating mechanism at right)  
Model 110 shown

Dimensions in inches (mm)  
Net weight: 500 lbs. (227 kg)

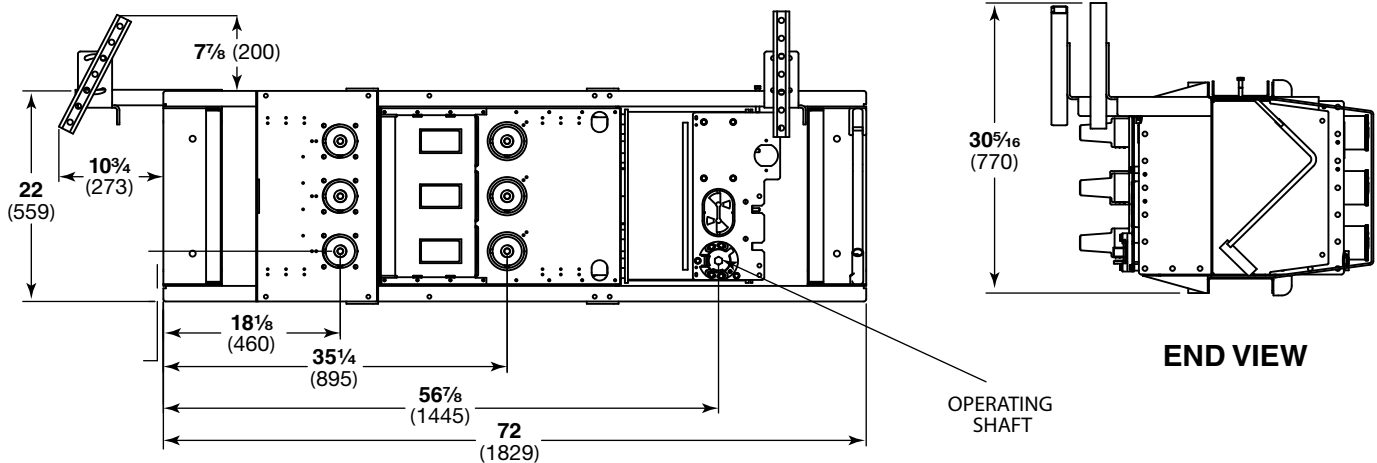

**FRONT VIEW**

**END VIEW**

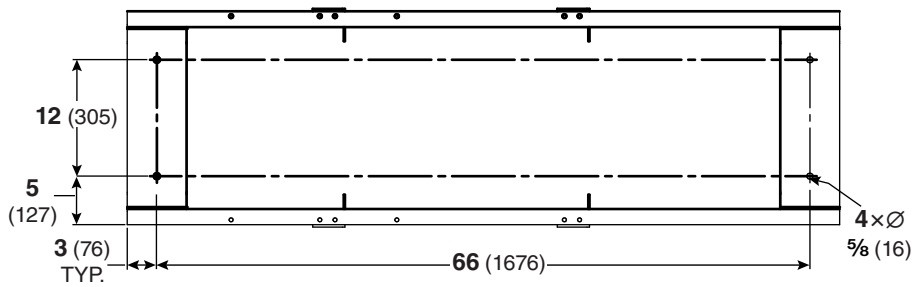

**ANCHOR BOLT PLAN**

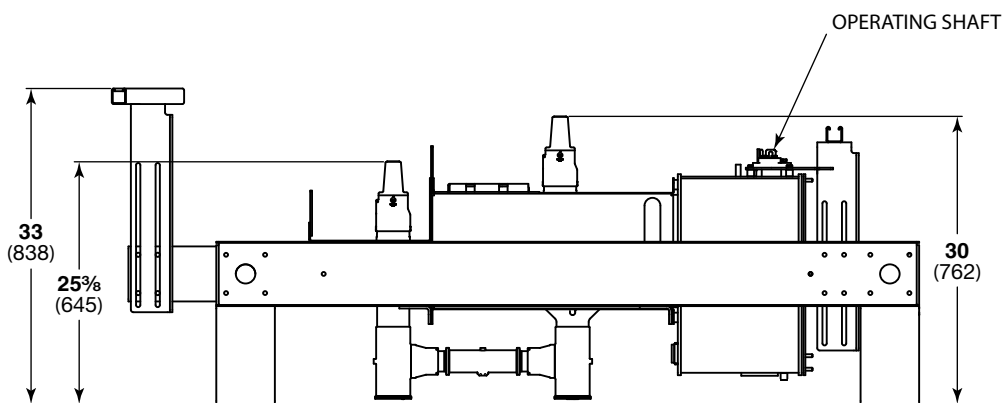

**SIDE VIEW**

**Wet-Vault Installation Style—Multi-Way Assemblies—Vertical Orientation**

Catalog number suffix “-V1” or “-V11” (Cables enter/exit from the top, operating mechanism at bottom)  
 Model 330 Shown

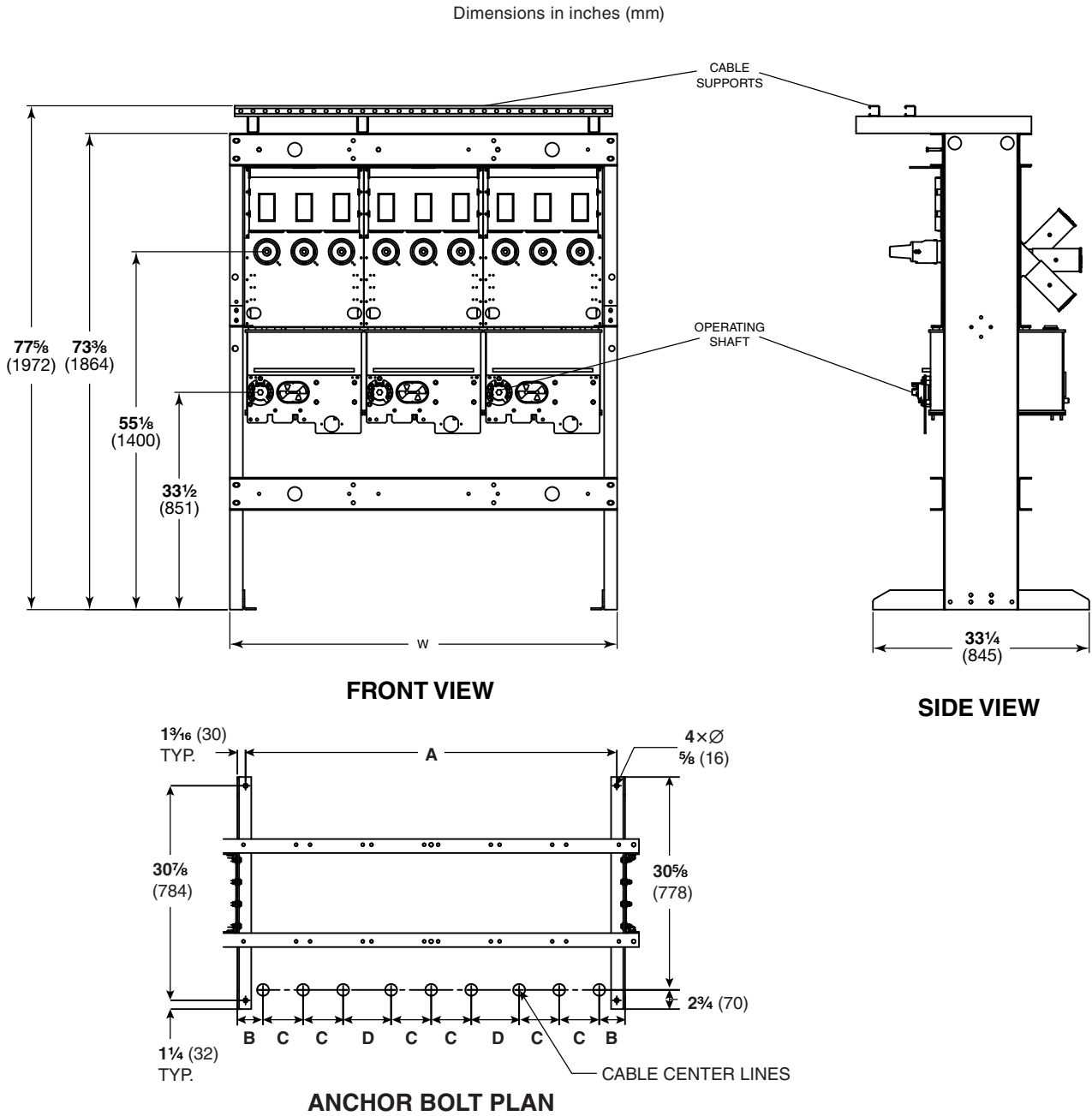

| Model                                | Dimensions in Inches (mm) |               |                |                |                   | Net Weight,<br>Lbs. (kg) |
|--------------------------------------|---------------------------|---------------|----------------|----------------|-------------------|--------------------------|
|                                      | A                         | B             | C              | D              | W                 |                          |
| 303, 312, 321, 330                   | 53 1/4<br>(1353)          | 3 3/4<br>(95) | 5 3/4<br>(146) | 6 7/8<br>(175) | 59 3/8<br>(1514)  | 1500<br>(680)            |
| 404, 413, 422, 431, 440              | 71 5/8<br>(1819)          | 3 3/4<br>(95) | 5 3/4<br>(146) | 6 7/8<br>(175) | 78<br>(1981)      | 2000<br>(907)            |
| 505, 514, 523, 532, 541, 550         | 90<br>(2286)              | 3 3/4<br>(95) | 5 3/4<br>(146) | 6 7/8<br>(175) | 96 3/8<br>(2448)  | 2500<br>(1134)           |
| 606, 615, 624, 633, 642,<br>651, 660 | 108 3/8<br>(2753)         | 3 3/4<br>(95) | 5 3/4<br>(146) | 6 7/8<br>(175) | 114 3/4<br>(2915) | 3000<br>(1361)           |

# Vista® SD Underground Distribution Switchgear

## Wet-Vault Installation Style—Multi-Way Assemblies—Vertical Orientation

Catalog number suffix “-V2” or “-V12” (Cables enter/exit from the bottom, operating mechanism at top)  
Model 330 Shown

Dimensions in inches (mm)

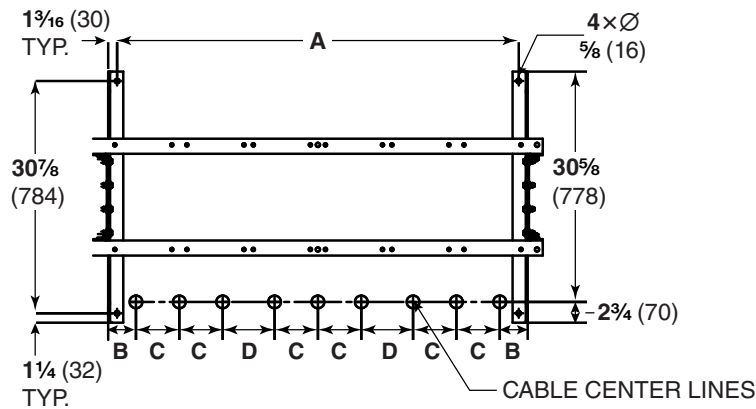
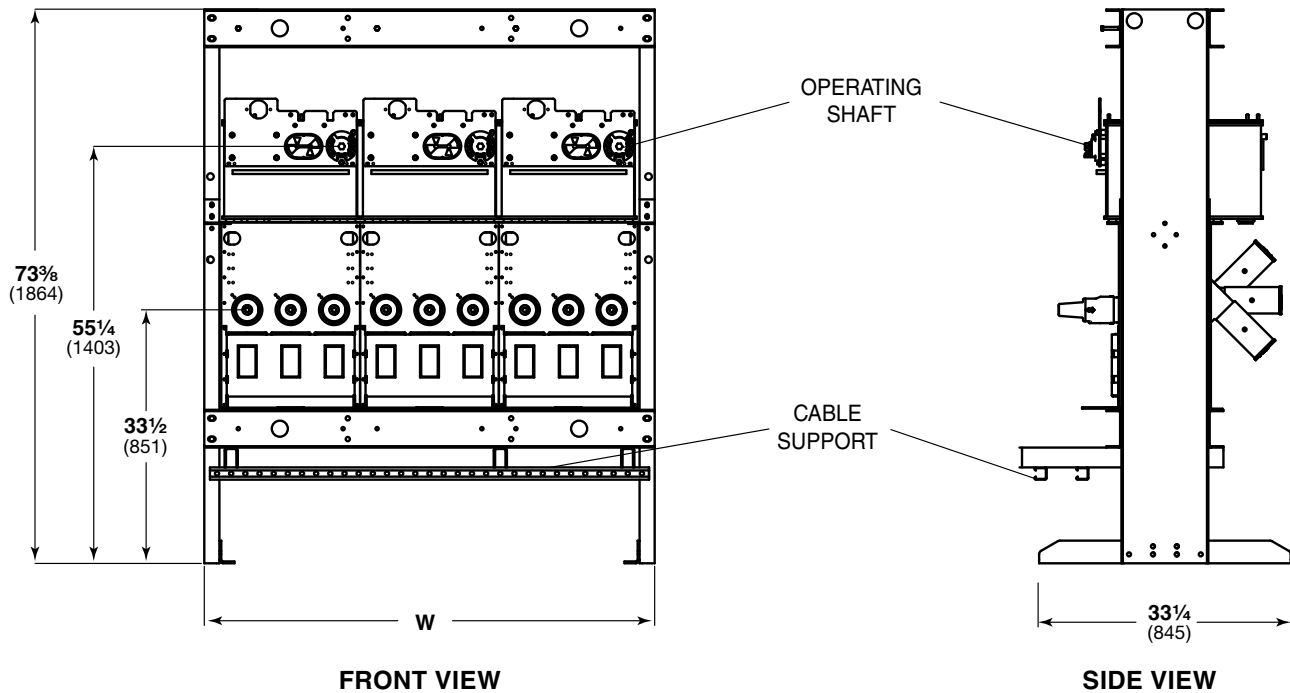

**ANCHOR BOLT PLAN**

| Model                                | Dimensions in Inches (mm)  |                        |                         |                         |                            | Net Weight,<br>Lbs. (kg) |
|--------------------------------------|----------------------------|------------------------|-------------------------|-------------------------|----------------------------|--------------------------|
|                                      | A                          | B                      | C                       | D                       | W                          |                          |
| 303, 312, 321, 330                   | $53\frac{1}{4}$<br>(1353)  | $3\frac{3}{4}$<br>(95) | $5\frac{3}{4}$<br>(146) | $6\frac{7}{8}$<br>(175) | $59\frac{3}{8}$<br>(1514)  | 1500<br>(680)            |
| 404, 413, 422, 431, 440              | $71\frac{1}{8}$<br>(1819)  | $3\frac{3}{4}$<br>(95) | $5\frac{3}{4}$<br>(146) | $6\frac{7}{8}$<br>(175) | 78<br>(1981)               | 2000<br>(907)            |
| 505, 514, 523, 532, 541, 550         | 90<br>(2286)               | $3\frac{3}{4}$<br>(95) | $5\frac{3}{4}$<br>(146) | $6\frac{7}{8}$<br>(175) | $96\frac{3}{8}$<br>(2448)  | 2500<br>(1134)           |
| 606, 615, 624, 633, 642,<br>651, 660 | $108\frac{3}{8}$<br>(2753) | $3\frac{3}{4}$<br>(95) | $5\frac{3}{4}$<br>(146) | $6\frac{7}{8}$<br>(175) | $114\frac{3}{4}$<br>(2915) | 3000<br>(1361)           |

**Pad-Mounted Installation Style—Models 210 or 201**

Catalog number suffix “-P1” or “-P11”

Model 210 Shown

Dimensions in inches (mm)  
 Net weight: 1050 lbs. (476 kg)

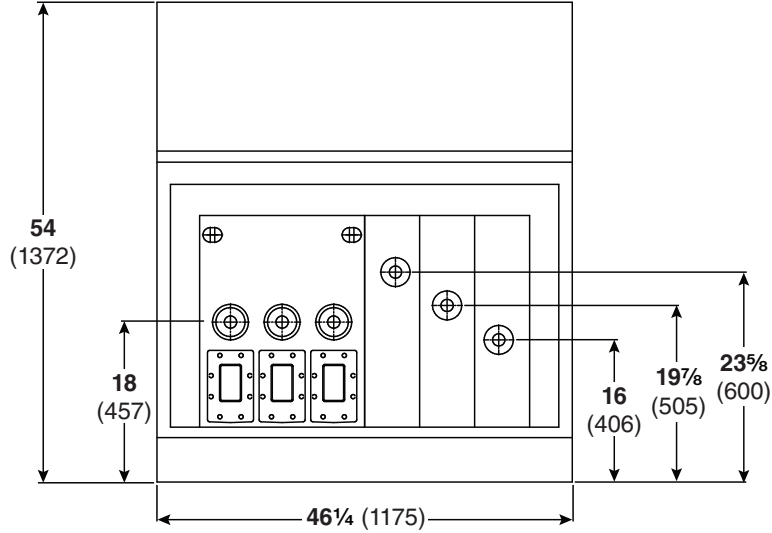

**FRONT VIEW**

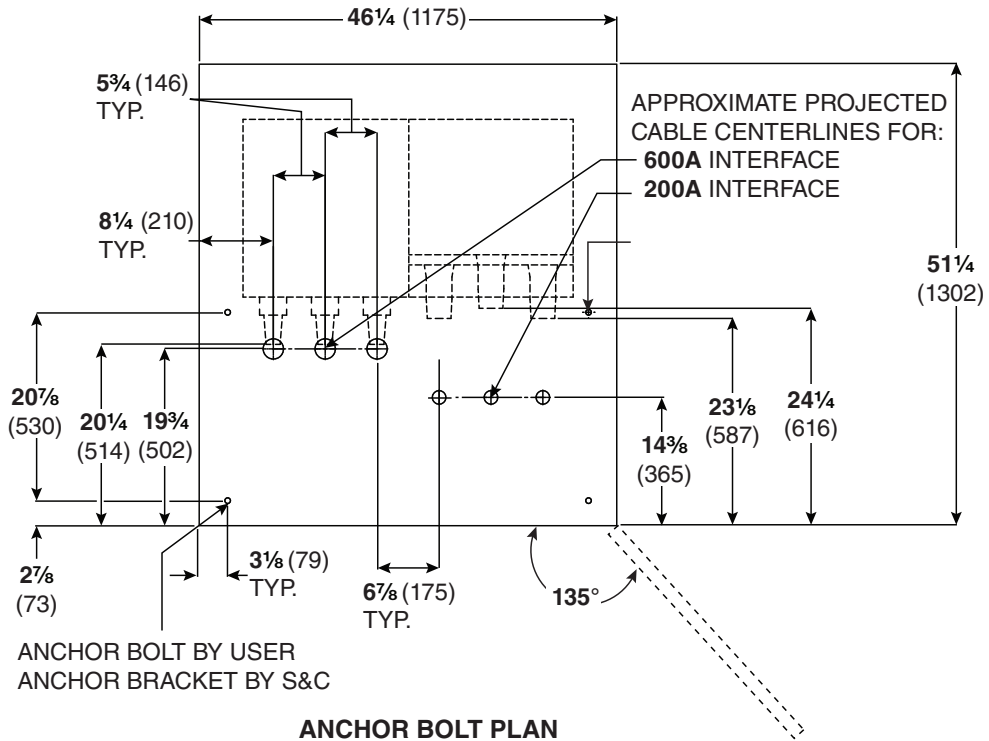

**ANCHOR BOLT PLAN**

# Vista® SD Underground Distribution Switchgear

## Pad-Mounted Installation Style—Models 210 or 201—Continued

Catalog number suffix “-P1” or “-P11”

Model 210 Shown

Dimensions in inches (mm)  
Net weight: 1050 lbs. (476 kg)

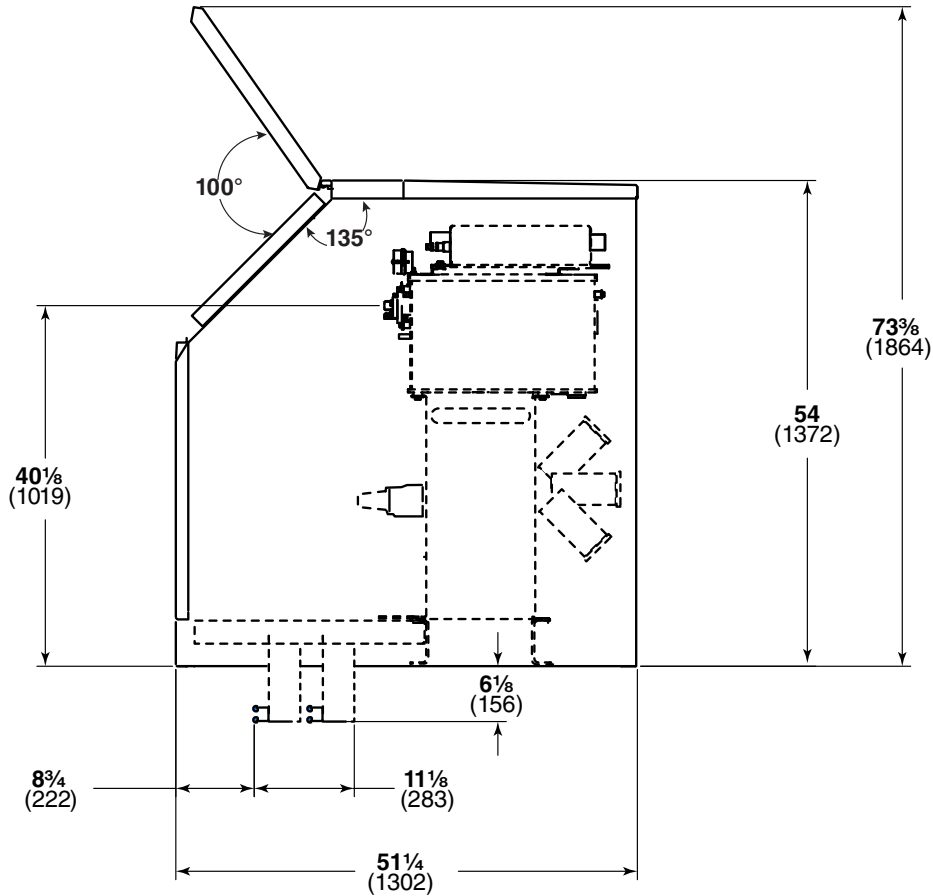

**SIDE VIEW**

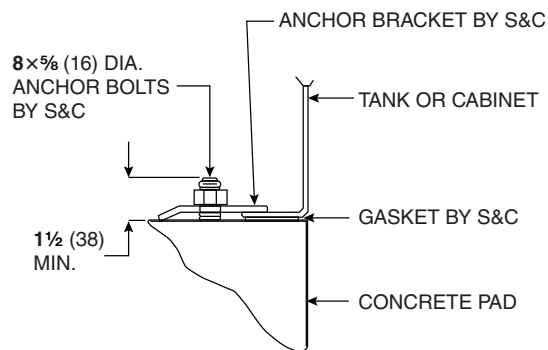

**ANCHOR BOLT DETAIL**



**Pad-Mounted Installation Style—Models 303, 312, 321, or 330**

Catalog number suffix “-P1” or “-P11”

Model 330 Shown

Dimensions in inches (mm)  
Net weight: 1950 lbs. (885 kg)

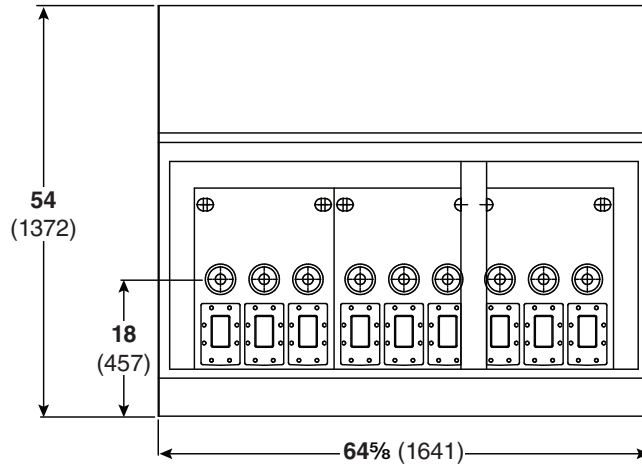

**FRONT VIEW**

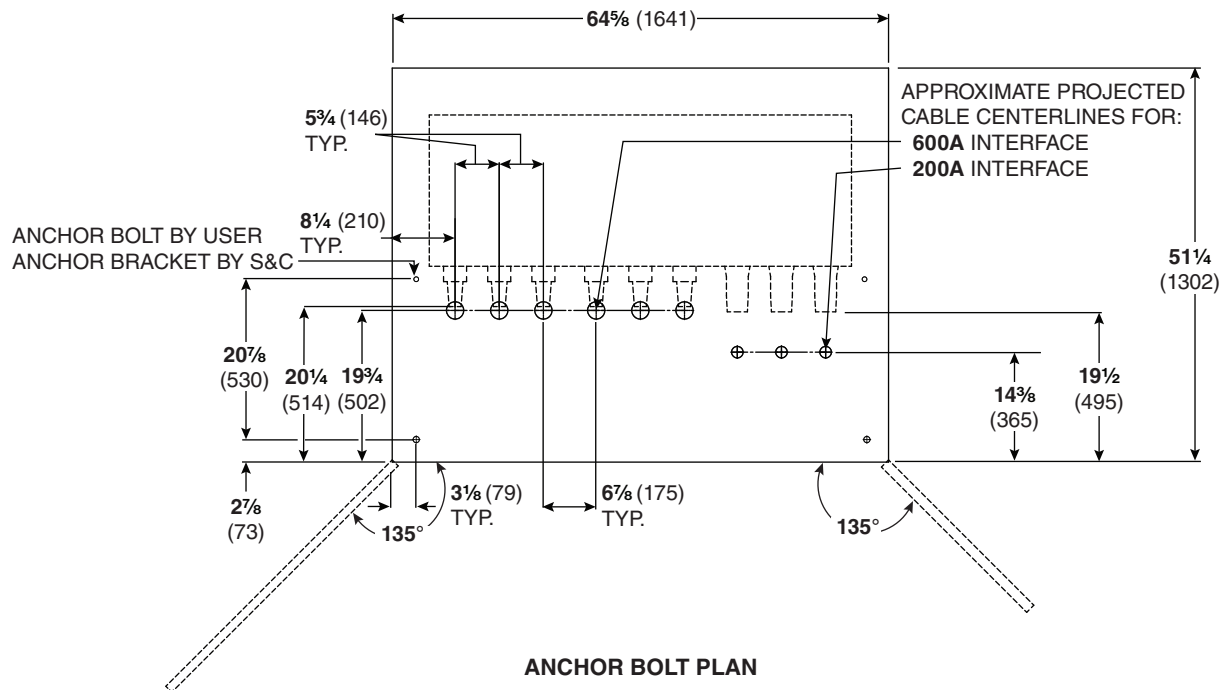

**ANCHOR BOLT PLAN**

# Vista® SD Underground Distribution Switchgear

## Pad-Mounted Installation Style—Models 303, 312, 321, or 330—Continued

Catalog number suffix “-P1” or “-P11”

Model 330 Shown

Dimensions in inches (mm)  
Net weight: 1950 lbs. (885 kg)

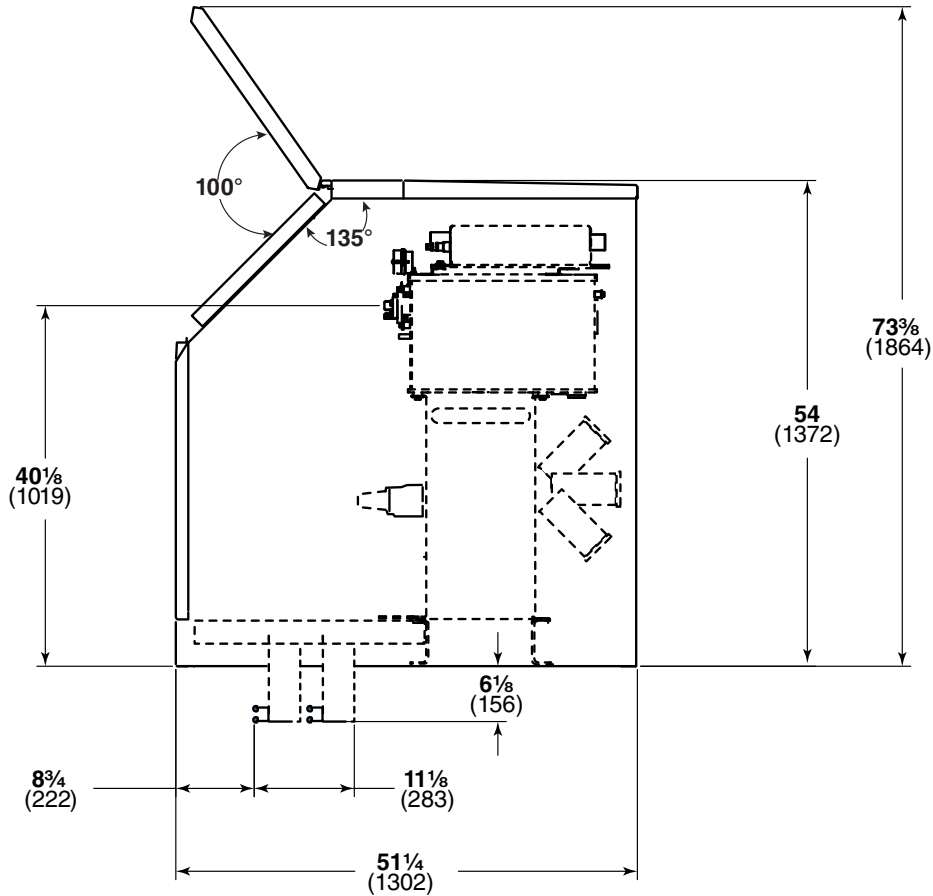

**SIDE VIEW**

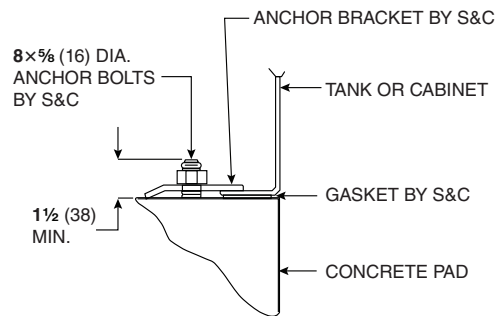

**ANCHOR BOLT DETAIL**

**Pad-Mounted Installation Style—Models 404, 413, 422, 431, or 440**

Catalog number suffix “-P1” or “-P11”

Model 440 Shown

Dimensions in inches (mm)  
Net weight: 2600 lbs. (1179 kg)

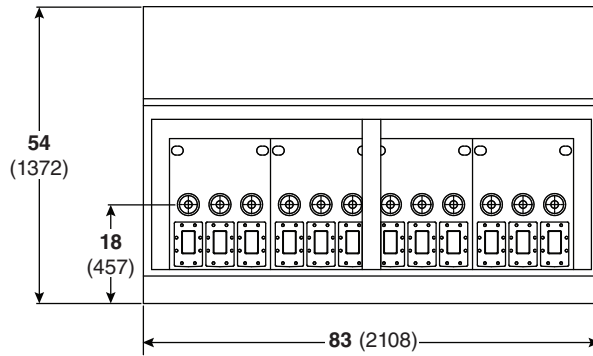

**FRONT VIEW**

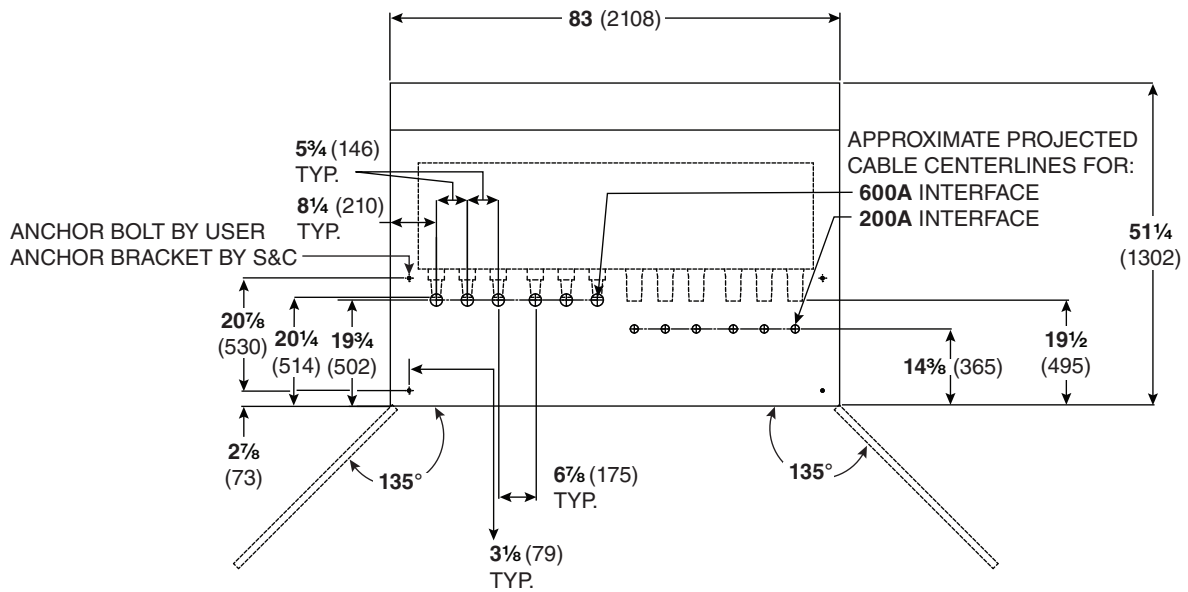

**ANCHOR BOLT PLAN**

# Vista® SD Underground Distribution Switchgear

## Pad-Mounted Installation Style—Models 404, 413, 422, 431, or 440—Continued

Catalog number suffix “-P1” or “-P11”

Model 440 Shown

Dimensions in inches (mm)  
Net weight: 2600 lbs. (1179 kg)

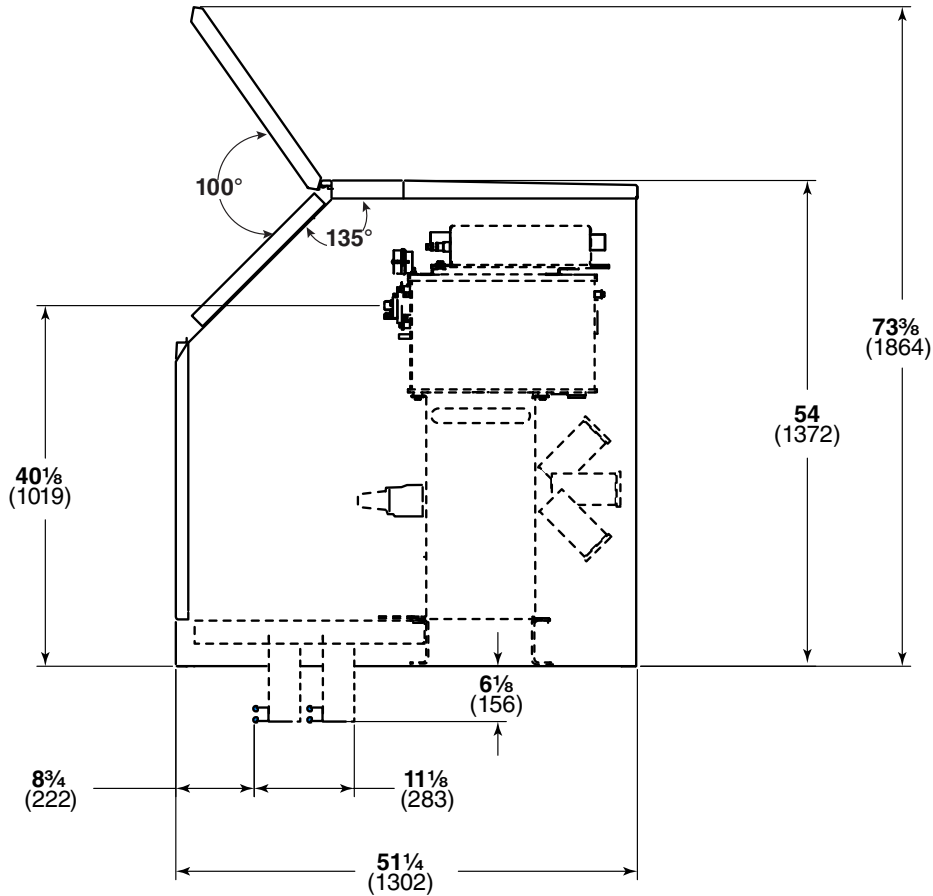

**SIDE VIEW**

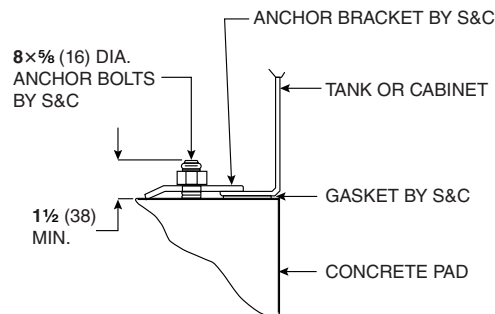

**ANCHOR BOLT DETAIL**

**Pad-Mounted Installation Style—Models 505, 514, 523, 532, 541, or 550**

Catalog number suffix “-P1” or “-P11”

Model 550 Shown

Dimensions in inches (mm)  
Net weight: 3250 lbs. (1474 kg)

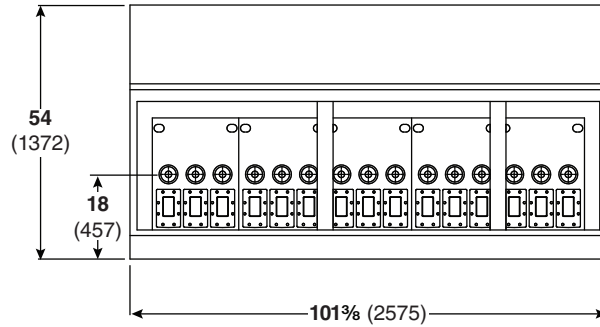

**FRONT VIEW**

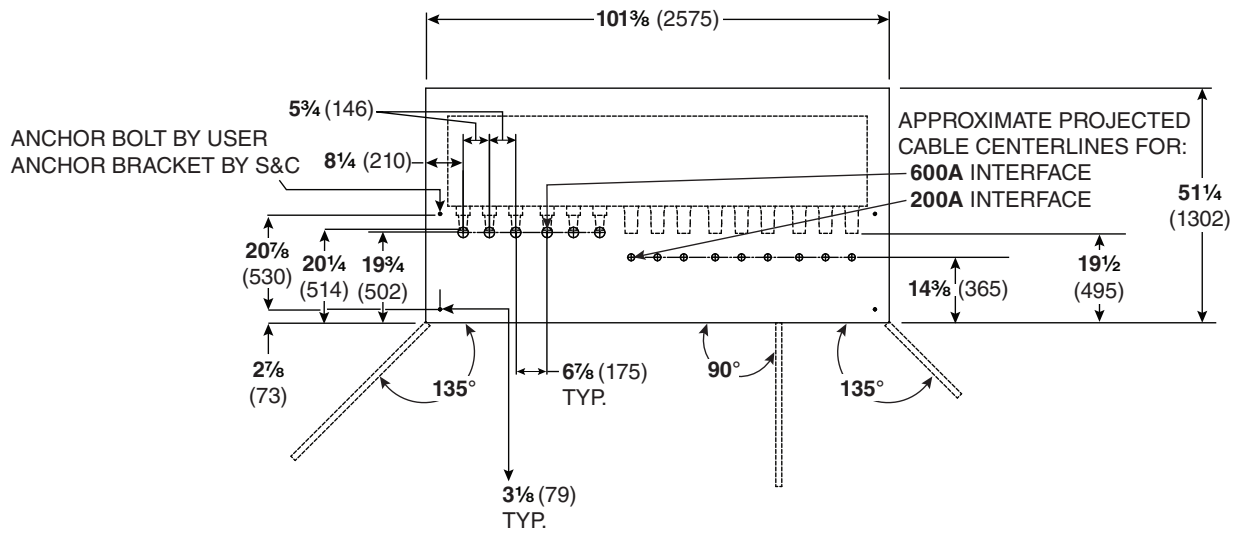

**ANCHOR BOLT PLAN**

# Vista® SD Underground Distribution Switchgear

## Pad-Mounted Installation Style—Models 505, 514, 523, 532, 541, or 550—Continued

Catalog number suffix “-P1” or “-P11”

Model 550 Shown

Dimensions in inches (mm)  
Net weight: 3250 lbs. (1474 kg)

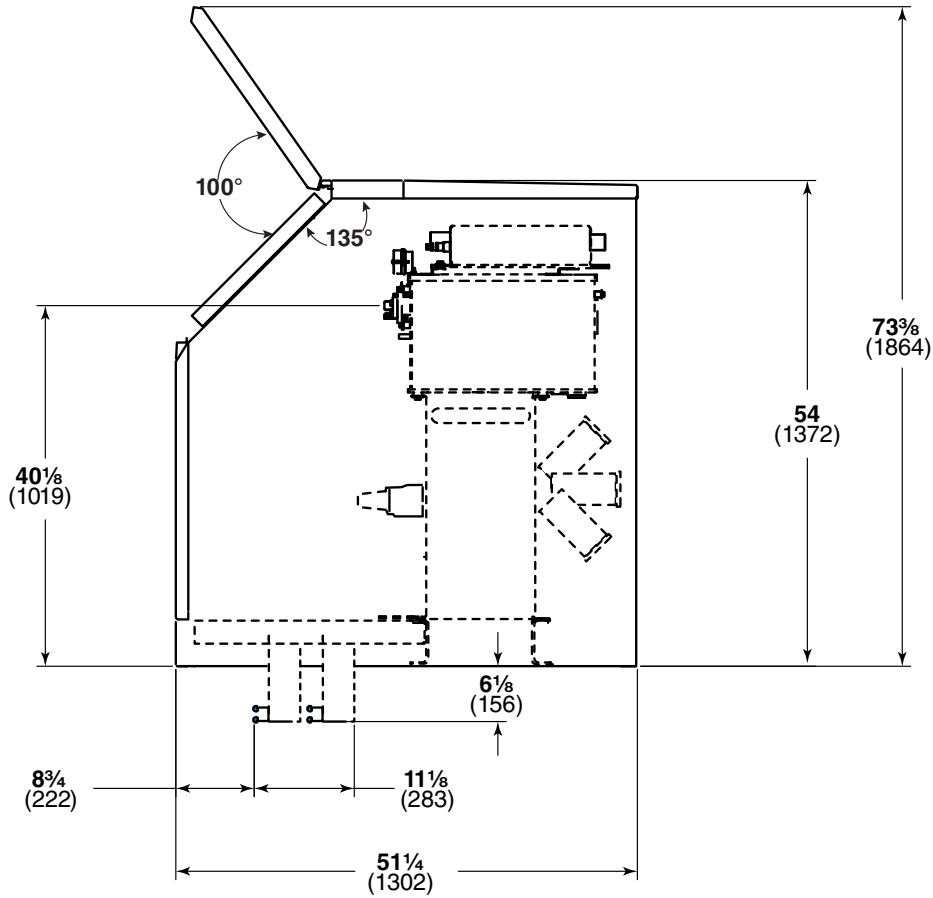

**SIDE VIEW**

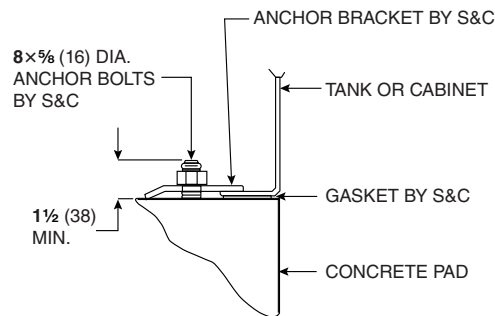

**ANCHOR BOLT DETAIL**

**Pad-Mounted Installation Style—Models 606, 615, 624, 633, 642, 651, or 660**

Catalog number suffix “-P1” or “-P11”

Model 660 Shown

Dimensions in inches (mm)  
Net weight: 3900 lbs. (1769 kg)

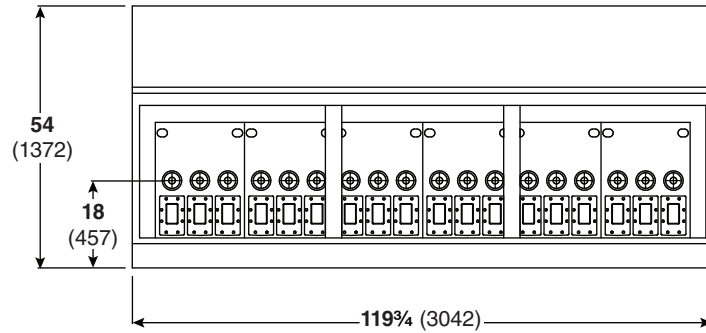

**FRONT VIEW**

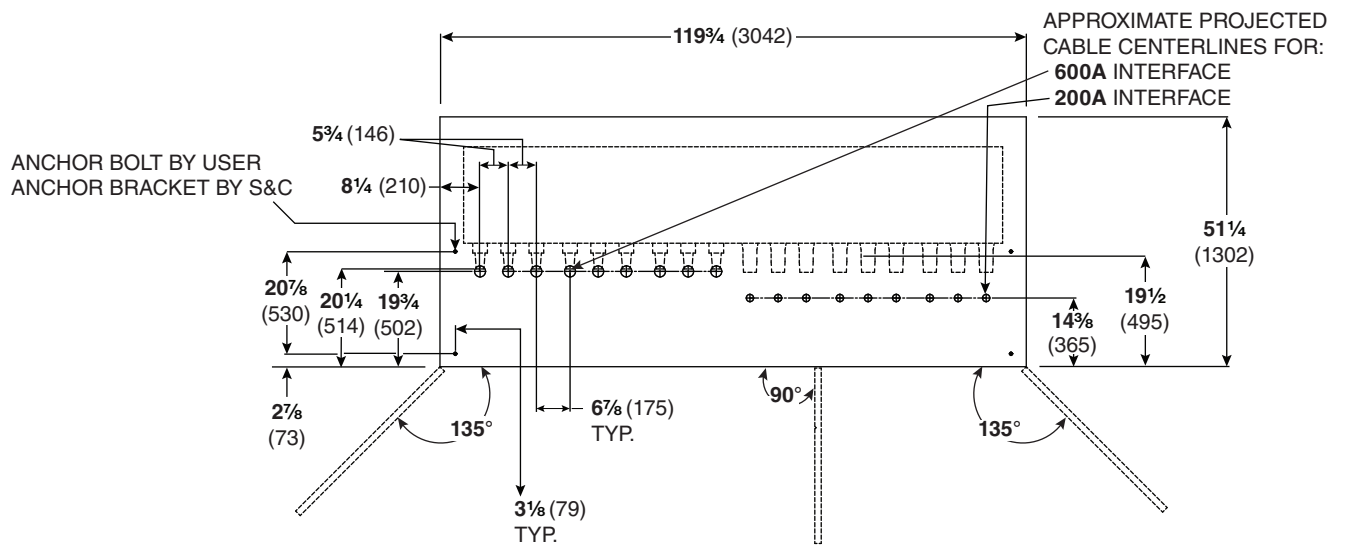

**ANCHOR BOLT PLAN**

# Vista® SD Underground Distribution Switchgear

## Pad-Mounted Installation Style—Models 606, 615, 624, 633, 642, 651, or 660—Continued

Catalog number suffix “-P1” or “-P11”

Model 660 Shown

Dimensions in inches (mm)  
Net weight: 3900 lbs. (1769 kg)

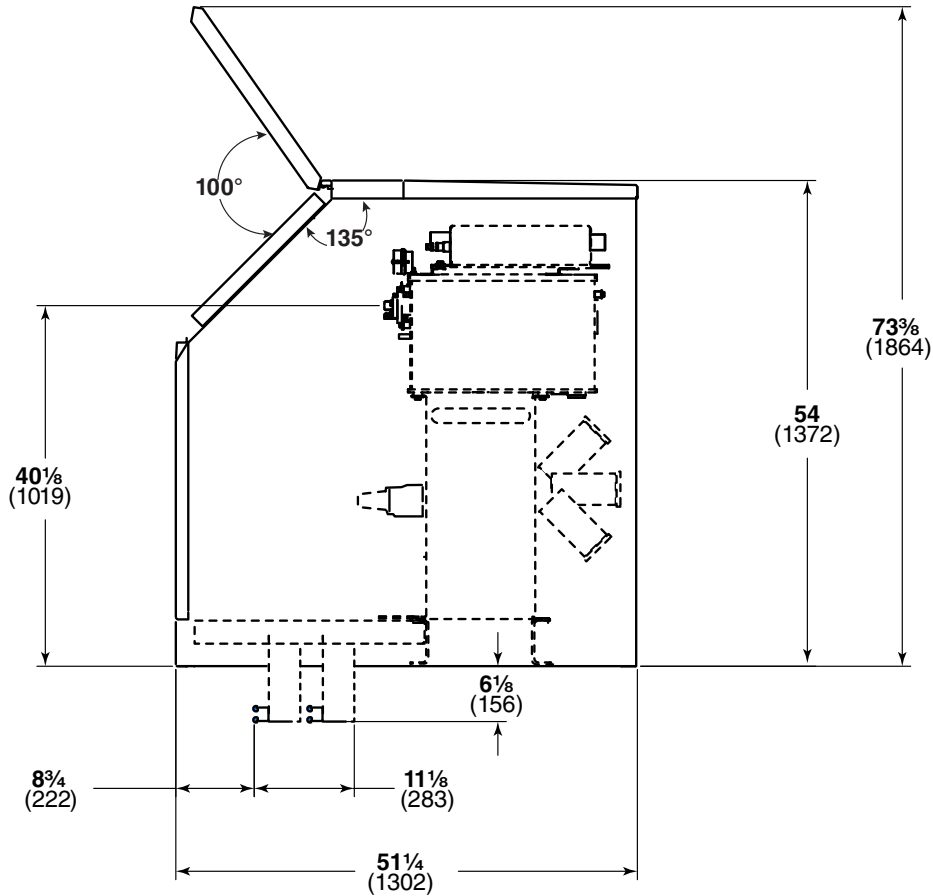

**SIDE VIEW**

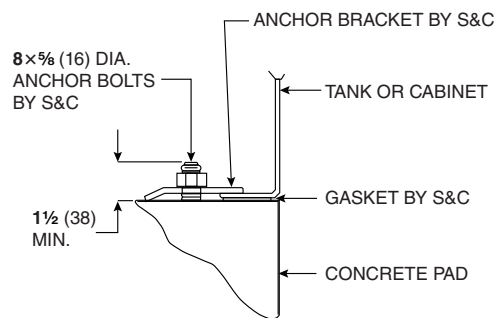

**ANCHOR BOLT DETAIL**



Vista SD Switchgear Motor Operator

Dimensions in inches (mm)

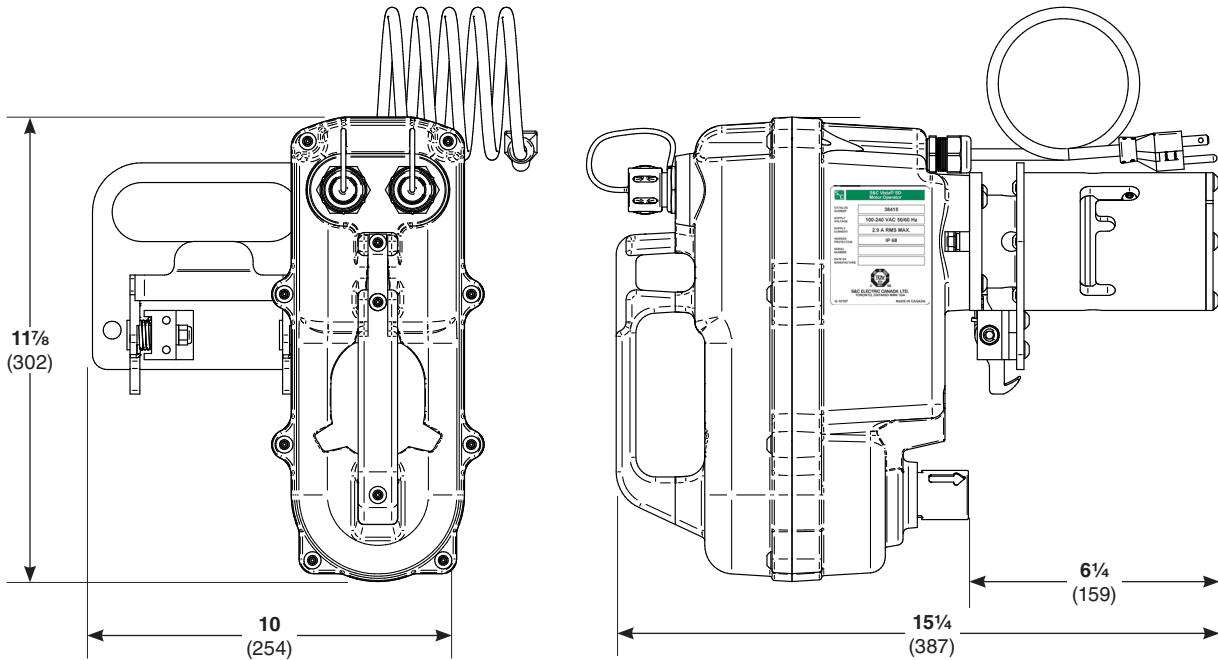

Vista SD Switchgear Portable Remote Control Pendant

